



**Höchstzulässige Werte / Maximum rated values**

**Elektrische Eigenschaften / Electrical properties**

Kollektor-Emitter-Sperrspannung collector-emitter voltage	$T_{vj} = 25^\circ\text{C}$	$V_{CES}$	1200	V
Kollektor-Dauergleichstrom DC-collector current	$T_C = 80^\circ\text{C}$	$I_{C,nom.}$	100	A
	$T_C = 25^\circ\text{C}$	$I_C$	205	A
Periodischer Kollektor Spitzenstrom repetitive peak collector current	$t_p = 1\text{ ms}, T_C = 80^\circ\text{C}$	$I_{CRM}$	200	A
Gesamt-Verlustleistung total power dissipation	$T_C = 25^\circ\text{C}, \text{Transistor}$	$P_{tot}$	830	W
Gate-Emitter-Spitzenspannung gate-emitter peak voltage		$V_{GES}$	+/- 20V	V
Dauergleichstrom DC forward current		$I_F$	100	A
Periodischer Spitzenstrom repetitive peak forw. current	$t_p = 1\text{ ms}$	$I_{FRM}$	200	A
Grenzlastintegral der Diode $I^2t$ - value, Diode	$V_R = 0V, t_p = 10\text{ms}, T_{vj} = 125^\circ\text{C}$	$I^2t$	1,71	$\text{k A}^2\text{s}$
Isolations-Prüfspannung insulation test voltage	RMS, $f = 50\text{ Hz}, t = 1\text{ min.}$	$V_{ISOL}$	2,5	kV

**Charakteristische Werte / Characteristic values**

**Transistor / Transistor**

min. typ. max.

Kollektor-Emitter Sättigungsspannung collector-emitter saturation voltage	$I_C = 100A, V_{GE} = 15V, T_{vj} = 25^\circ\text{C}$	$V_{CE\text{ sat}}$	-	2,1	2,6	V
	$I_C = 100A, V_{GE} = 15V, T_{vj} = 125^\circ\text{C}$		-	2,4	2,9	V
Gate-Schwellenspannung gate threshold voltage	$I_C = 4\text{mA}, V_{CE} = V_{GE}, T_{vj} = 25^\circ\text{C}$	$V_{GE(th)}$	4,5	5,5	6,5	V
Gateladung gate charge	$V_{GE} = -15V...+15V$	$Q_G$	-	1,1	-	$\mu\text{C}$
Eingangskapazität input capacitance	$f = 1\text{MHz}, T_{vj} = 25^\circ\text{C}, V_{CE} = 25V, V_{GE} = 0V$	$C_{ies}$	-	6,5	-	nF
Rückwirkungskapazität reverse transfer capacitance	$f = 1\text{MHz}, T_{vj} = 25^\circ\text{C}, V_{CE} = 25V, V_{GE} = 0V$	$C_{res}$	-	0,5	-	nF
Kollektor-Emitter Reststrom collector-emitter cut-off current	$V_{CE} = 1200V, V_{GE} = 0V, T_{vj} = 25^\circ\text{C}$	$I_{CES}$	-	-	5	mA
Gate-Emitter Reststrom gate-emitter leakage current	$V_{CE} = 0V, V_{GE} = 20V, T_{vj} = 25^\circ\text{C}$	$I_{GES}$	-	-	400	nA

prepared by: MOD-D2; Mark Münzer

date of publication: 2003-01-23

approved by: SM TM; Wilhelm Rusche

revision: 3.0

# Technische Information / Technical Information

eupec

IGBT-Module  
IGBT-Modules

## BSM100GAL120DLC K



### Charakteristische Werte / Characteristic values

#### Transistor / Transistor

			min.	typ.	max.	
Einschaltverzögerungszeit (ind. Last) turn on delay time (inductive load)	$I_C = 100A, V_{CE} = 600V$	$t_{d,on}$	-	0,06	-	$\mu s$
	$V_{GE} = \pm 15V, R_G = 5,6\Omega, T_{vj} = 25^\circ C$		-	0,06	-	$\mu s$
	$V_{GE} = \pm 15V, R_G = 5,6\Omega, T_{vj} = 125^\circ C$		-	0,06	-	$\mu s$
Anstiegszeit (induktive Last) rise time (inductive load)	$I_C = 100A, V_{CE} = 600V$	$t_r$	-	0,05	-	$\mu s$
	$V_{GE} = \pm 15V, R_G = 5,6\Omega, T_{vj} = 25^\circ C$		-	0,05	-	$\mu s$
	$V_{GE} = \pm 15V, R_G = 5,6\Omega, T_{vj} = 125^\circ C$		-	0,05	-	$\mu s$
Abschaltverzögerungszeit (ind. Last) turn off delay time (inductive load)	$I_C = 100A, V_{CE} = 600V$	$t_{d,off}$	-	0,35	-	$\mu s$
	$V_{GE} = \pm 15V, R_G = 5,6\Omega, T_{vj} = 25^\circ C$		-	0,40	-	$\mu s$
	$V_{GE} = \pm 15V, R_G = 5,6\Omega, T_{vj} = 125^\circ C$		-	0,40	-	$\mu s$
Fallzeit (induktive Last) fall time (inductive load)	$I_C = 100A, V_{CE} = 600V$	$t_f$	-	0,06	-	$\mu s$
	$V_{GE} = \pm 15V, R_G = 5,6\Omega, T_{vj} = 25^\circ C$		-	0,08	-	$\mu s$
	$V_{GE} = \pm 15V, R_G = 5,6\Omega, T_{vj} = 125^\circ C$		-	0,08	-	$\mu s$
Einschaltverlustenergie pro Puls turn-on energy loss per pulse	$I_C = 100A, V_{CE} = 600V, V_{GE} = \pm 15V$ $R_G = 5,6\Omega, T_{vj} = 125^\circ C, L_\sigma = 60nH$	$E_{on}$	-	10	-	mJ
Abschaltverlustenergie pro Puls turn-off energy loss per pulse	$I_C = 100A, V_{CE} = 600V, V_{GE} = \pm 15V$ $R_G = 5,6\Omega, T_{vj} = 125^\circ C, L_\sigma = 60nH$	$E_{off}$	-	12	-	mJ
Kurzschlußverhalten SC Data	$t_p \leq 10\mu s, V_{GE} \leq 15V, R_G = 5,6\Omega$ $T_{vj} \leq 125^\circ C, V_{CC} = 900V, V_{CEmax} = V_{CES} - L_{\sigma CE} \cdot di/dt$	$I_{SC}$	-	650	-	A
Modulinduktivität stray inductance module		$L_{\sigma CE}$	-	40	-	nH
Modul Leitungswiderstand, Anschlüsse – Chip module lead resistance, terminals – chip	$T_C = 25^\circ C$	$R_{CC+EE}$	-	0,85	-	m $\Omega$

### Charakteristische Werte / Characteristic values

#### Inversdiode / free-wheel diode

			min.	typ.	max.	
Durchlaßspannung forward voltage	$I_F = 100A, V_{GE} = 0V, T_{vj} = 25^\circ C$	$V_F$	-	1,8	2,3	V
	$I_F = 100A, V_{GE} = 0V, T_{vj} = 125^\circ C$		-	1,7	2,2	V
Rückstromspitze peak reverse recovery current	$I_F = 100A, -di_F/dt = 2700A/\mu s$	$I_{RM}$	-	125	-	A
	$V_R = 600V, V_{GE} = -15V, T_{vj} = 25^\circ C$		-	155	-	A
	$V_R = 600V, V_{GE} = -15V, T_{vj} = 125^\circ C$		-	155	-	A
Sperrverzögerungsladung recovered charge	$I_F = 100A, -di_F/dt = 2700A/\mu s$	$Q_r$	-	12	-	$\mu C$
	$V_R = 600V, V_{GE} = -15V, T_{vj} = 25^\circ C$		-	22	-	$\mu C$
	$V_R = 600V, V_{GE} = -15V, T_{vj} = 125^\circ C$		-	22	-	$\mu C$
Abschaltenergie pro Puls reverse recovery energy	$I_F = 100A, -di_F/dt = 2700A/\mu s$	$E_{rec}$	-	4	-	mJ
	$V_R = 600V, V_{GE} = -15V, T_{vj} = 25^\circ C$		-	9	-	mJ
	$V_R = 600V, V_{GE} = -15V, T_{vj} = 125^\circ C$		-	9	-	mJ

#### Chopperdiode / chopper diode

			min.	typ.	max.	
Durchlaßspannung forward voltage	$I_F = 150A, V_{GE} = 0V, T_{vj} = 25^\circ C$	$V_F$	-	1,8	2,3	V
	$I_F = 150A, V_{GE} = 0V, T_{vj} = 125^\circ C$		-	1,7	2,2	V
Rückstromspitze peak reverse recovery current	$I_F = 150A, -di_F/dt = 3100A/\mu s$	$I_{RM}$	-	180	-	A
	$V_R = 600V, V_{GE} = -15V, T_{vj} = 25^\circ C$		-	220	-	A
	$V_R = 600V, V_{GE} = -15V, T_{vj} = 125^\circ C$		-	220	-	A
Sperrverzögerungsladung recovered charge	$I_F = 150A, -di_F/dt = 3100A/\mu s$	$Q_r$	-	17	-	$\mu C$
	$V_R = 600V, V_{GE} = -15V, T_{vj} = 25^\circ C$		-	32	-	$\mu C$
	$V_R = 600V, V_{GE} = -15V, T_{vj} = 125^\circ C$		-	32	-	$\mu C$
Abschaltenergie pro Puls reverse recovery energy	$I_F = 150A, -di_F/dt = 3100A/\mu s$	$E_{rec}$	-	4	-	mJ
	$V_R = 600V, V_{GE} = -15V, T_{vj} = 25^\circ C$		-	10	-	mJ
	$V_R = 600V, V_{GE} = -15V, T_{vj} = 125^\circ C$		-	10	-	mJ

# Technische Information / Technical Information

eupec

IGBT-Module  
IGBT-Modules

## BSM100GAL120DLC K



### Thermische Eigenschaften / Thermal properties

			min.	typ.	max.	
Innerer Wärmewiderstand thermal resistance, junction to case	Transistor Wecheln. / transistor inverter	$R_{thJC}$	-	-	0,15	K/W
	Inversdiode / free wheel diode		-	-	0,30	K/W
	Chopper Diode / chopper diode		-	-	0,25	K/W
Übergangs-Wärmewiderstand thermal resistance, case to heatsink	pro Modul / per module $\lambda_{Flussite} = 1 \text{ W/m} \cdot \text{K}$ / $\lambda_{grease} = 1 \text{ W/m} \cdot \text{K}$	$R_{thCK}$	-	0,05	-	K/W
Höchstzulässige Sperrschichttemperatur maximum junction temperature		$T_{vj \max}$	-	-	150	°C
Betriebstemperatur operation temperature		$T_{vj \text{ op}}$	-40	-	125	°C
Lagertemperatur storage temperature		$T_{stg}$	-40	-	125	°C

### Mechanische Eigenschaften / Mechanical properties

Gehäuse, siehe Anlage case, see appendix						
Innere Isolation internal insulation				$\text{Al}_2\text{O}_3$		
Kriechstrecke creepage distance				20		mm
Luftstrecke clearance distance				11		mm
CTI comperative tracking index				275		
Anzugsdrehmoment f. mech. Befestigung mounting torque	Schraube / screw M6	M	3,0	-	6,0	Nm
Anzugsdrehmoment f. elektr. Anschlüsse terminal connection torque	Anschlüsse / terminals M5	M	2,5	-	5,0	Nm
Gewicht weight		G		250		g

Mit dieser technischen Information werden Halbleiterbauelemente spezifiziert, jedoch keine Eigenschaften zugesichert. Sie gilt in Verbindung mit den zugehörigen Technischen Erläuterungen.

This technical information specifies semiconductor devices but promises no characteristics. It is valid in combination with the belonging technical notes.



**Ausgangskennlinie (typisch)**  
**Output characteristic (typical)**

**$I_C = f(V_{CE})$**   
 **$V_{GE} = 15V$**

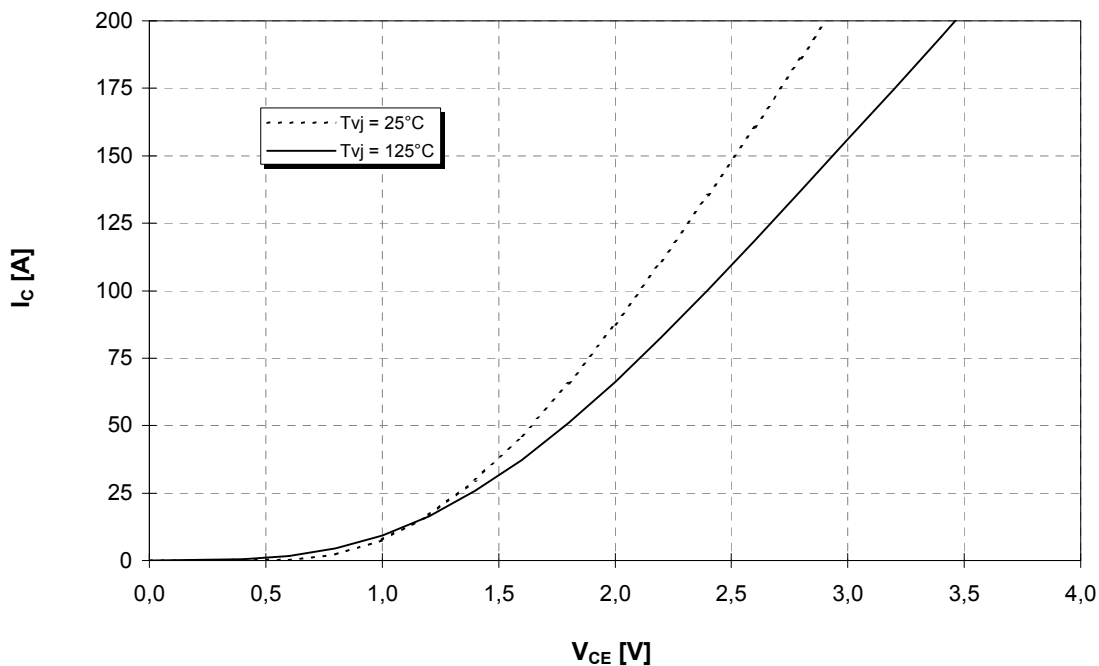

**Ausgangskennlinienfeld (typisch)**  
**Output characteristic (typical)**

**$I_C = f(V_{CE})$**   
 **$T_{vj} = 125^\circ C$**

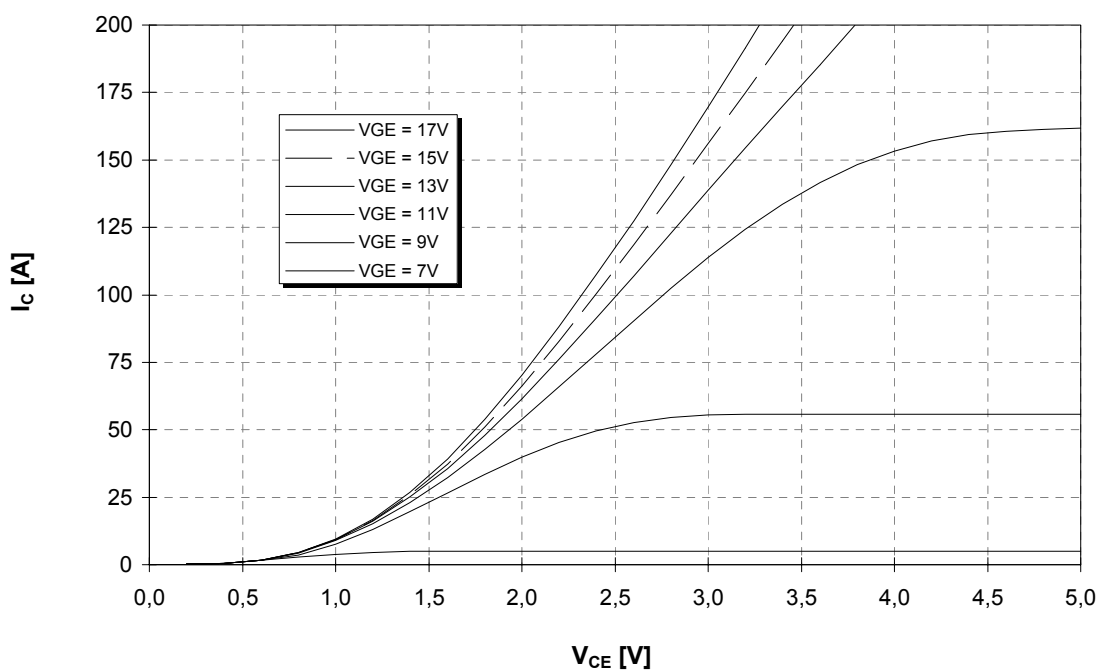



Übertragungscharakteristik (typisch)  
Transfer characteristic (typical)

$I_C = f(V_{GE})$   
 $V_{CE} = 20V$

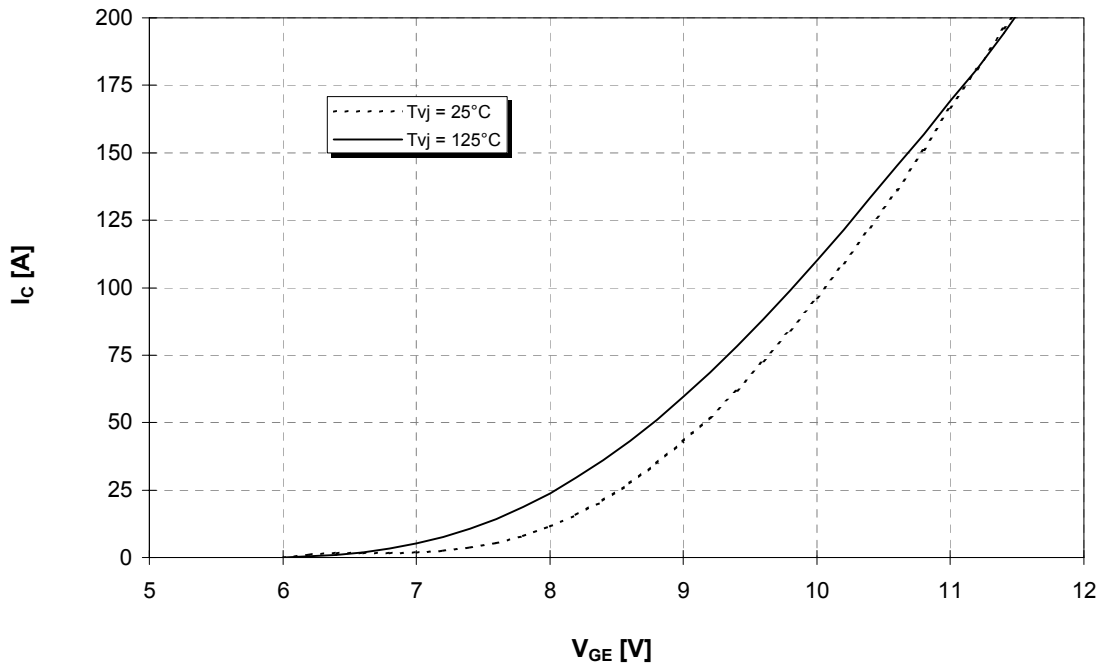

Durchlaßkennlinie der Inversdiode (typisch)  
Forward characteristic of inverse diode (typical)

$I_F = f(V_F)$

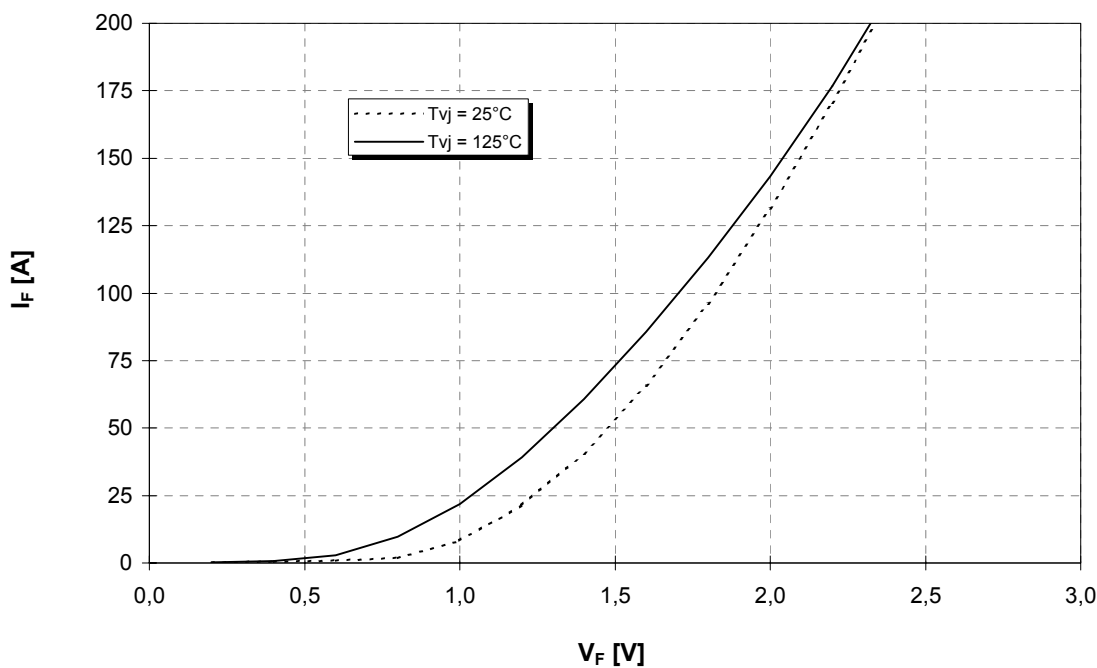



**Schaltverluste (typisch)  $E_{on} = f(I_C)$ ,  $E_{off} = f(I_C)$ ,  $E_{rec} = f(I_C)$**   
**Switching losses (typical)  $V_{GE} = \pm 15V$ ,  $R_G = 5,6 \Omega$ ,  $V_{CE} = 600V$ ,  $T_{vj} = 125^\circ C$**

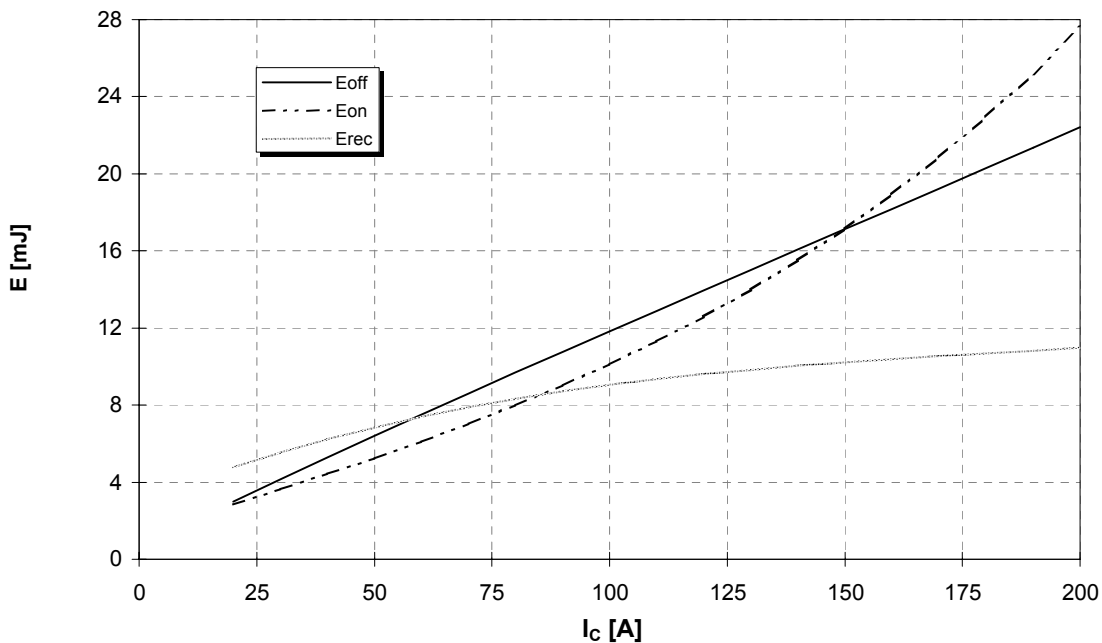

**Schaltverluste (typisch)  $E_{on} = f(R_G)$ ,  $E_{off} = f(R_G)$ ,  $E_{rec} = f(R_G)$**   
**Switching losses (typical)  $V_{GE} = \pm 15V$ ,  $I_C = 100A$ ,  $V_{CE} = 600V$ ,  $T_{vj} = 125^\circ C$**

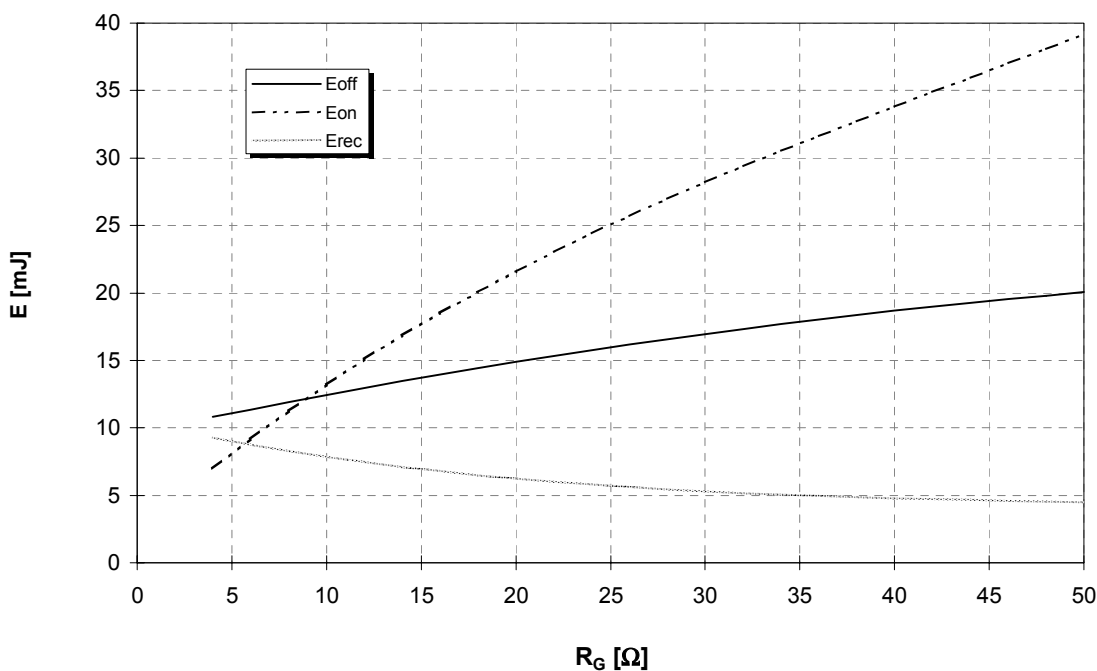



**Transienter Wärmewiderstand**  
**Transient thermal impedance**

$Z_{thJC} = f(t)$

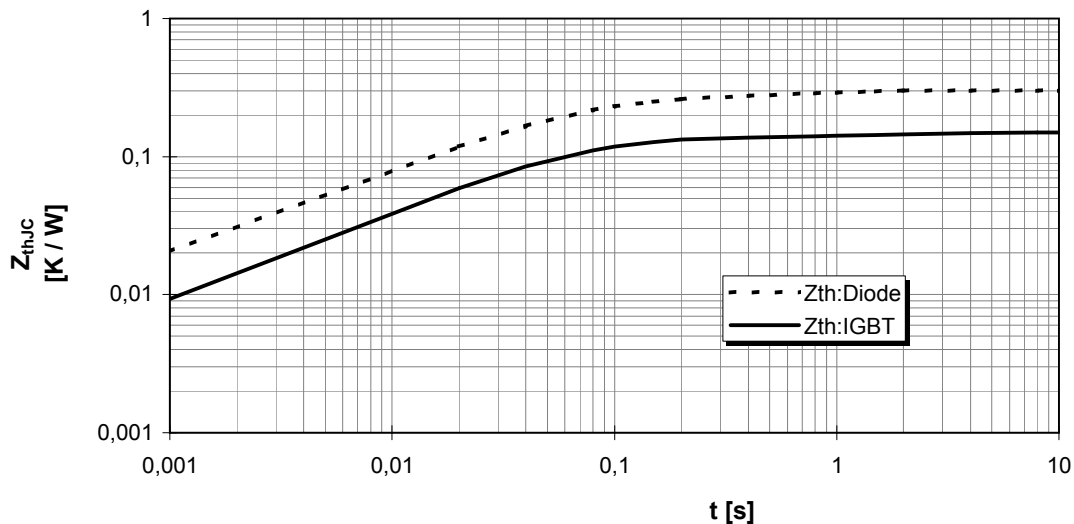

i	1	2	3	4
$r_i$ [K/kW] : IGBT	16,78	50,78	66,16	16,28
$\tau_i$ [s] : IGBT	0,002	0,03	0,066	1,655
$r_i$ [K/kW] : Diode	39,26	103,98	113,45	43,31
$\tau_i$ [s] : Diode	0,002	0,03	0,072	0,682

**Sicherer Arbeitsbereich (RBSOA)**

**Reverse bias safe operation area (RBSOA)**

$V_{GE} = 15V, R_G = 5,6 \Omega, T_{vj} = 125^\circ C$

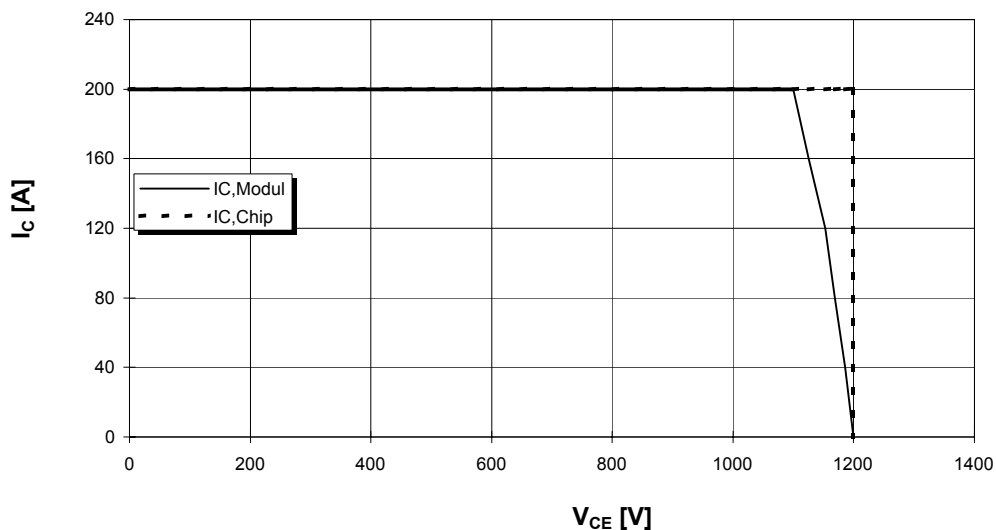

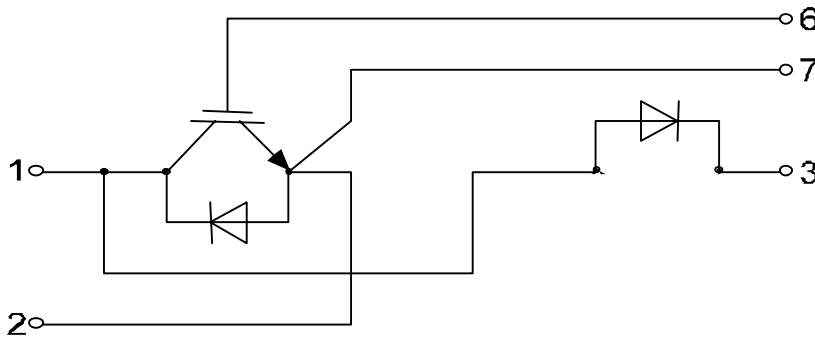
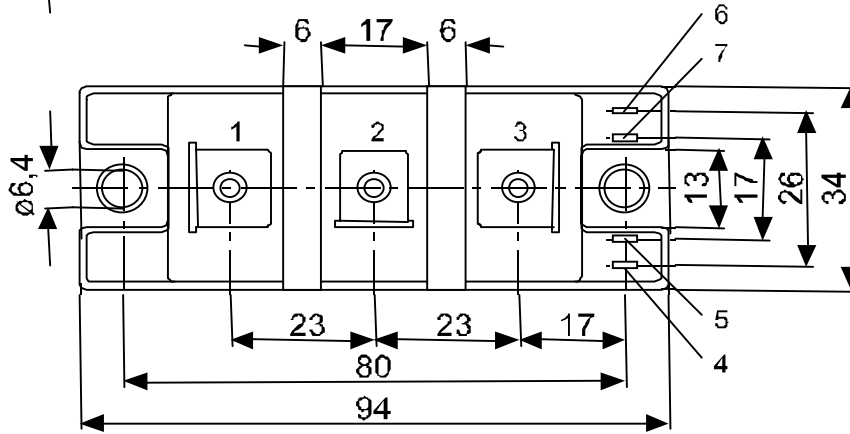
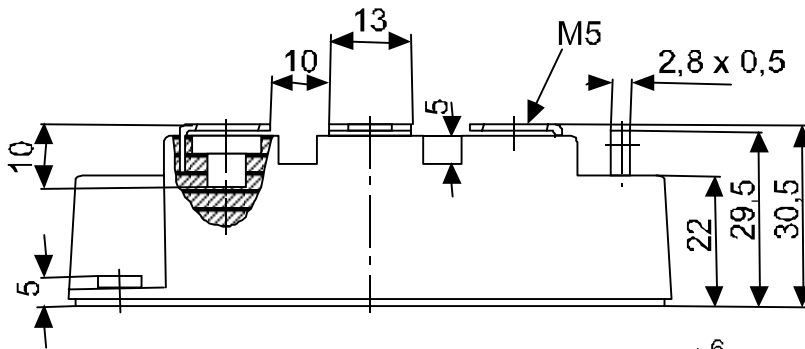

## **Terms & Conditions of Usage**

### **Attention**

The present product data is exclusively subscribed to technically experienced staff. This Data Sheet is describing the specification of the products for which a warranty is granted exclusively pursuant the terms and conditions of the supply agreement. There will be no guarantee of any kind for the product and its specifications. Changes to the Data Sheet are reserved.

You and your technical departments will have to evaluate the suitability of the product for the intended application and the completeness of the product data with respect to such application. Should you require product information in excess of the data given in the Data Sheet, please contact your local Sales Office via "[www.eupec.com / sales & contact](http://www.eupec.com / sales & contact)".

### **Warning**

Due to technical requirements the products may contain dangerous substances. For information on the types in question please contact your local Sales Office via "[www.eupec.com / sales & contact](http://www.eupec.com / sales & contact)".