

DIODE MODULE

DWF(R)40A30/40

TOP



DWF(R)40A is a non-isolated diode module designed for 3 phase rectification.

- $I_{F(AV)}=40A$, $V_{RRM}=400V$
- Easy Construction with Joint-Cathode (F) Type and Joint-Anode (R) type.
- Non-isolated. (Mounting Base as terminals.)
- High Surge Capability

(Applications)

- Welding Power Supply
- 3 Phase Rectifier

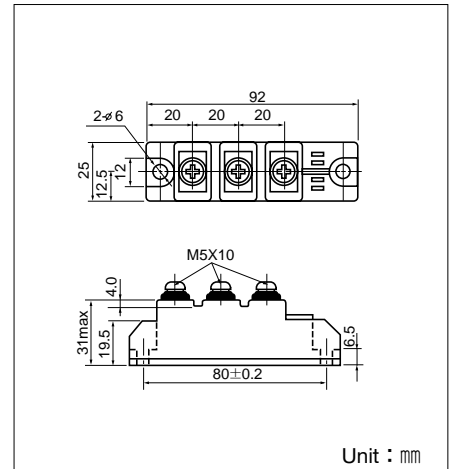
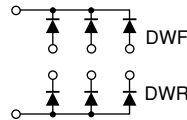

Unit : mm

Maximum Ratings

($T_j=25^\circ C$ unless otherwise specified)

Symbol	Item	Ratings		Unit
		DWF(R)40A30	DWF(R)40A40	
V_{RRM}	Repetitive Peak Reverse Voltage	300	400	V
V_{RSM}	Non-Repetitive Peak Reverse Voltage	360	480	V
$V_{R(DC)}$	D.C. Reverse Voltage	240	320	V

Symbol	Item	Conditions	Ratings	Unit	
$I_{F(AV)}$	Average Forward Current	Single phase, half wave, 180° conduction, $T_c : 122^\circ C$	40	A	
$I_{F(RMS)}$	R.M.S. Forward Current	Single phase, half wave, 180° conduction, $T_c : 122^\circ C$	62	A	
I_{FSM}	Surge Forward Current	$\frac{1}{2}$ cycle, 60Hz, peak value, non-repetitive	800	A	
I^2t	I^2t	Value for one cycle of surge current	2700	A ² S	
T_j	Operating Junction Temperature		-30 to +150	$^\circ C$	
T_{stg}	Storage Temperature		-30 to +125	$^\circ C$	
	Mounting Torque	Mounting (M5)	Recommended Value 1.5-2.5 (15-25)	2.7 (28)	N·m (kgf·cm)
		Terminal (M5)	Recommended Value 1.5-2.5 (15-25)	2.7 (28)	
	Mass			170	g

Electrical Characteristics

Symbol	Item	Conditions	Ratings	Unit
I_{RRM}	Repetitive Peak Reverse Current, max.	at V_{DRM} , single phase, half wave, $T_j=150^\circ C$	8	mA
V_{FM}	Forward Voltage Drop, max.	Forward current 120A, $T_j=25^\circ C$, Inst. measurement	1.15	V
$R_{th(j-c)}$	Thermal Impedance, max.	Junction to case	0.60	$^\circ C/W$

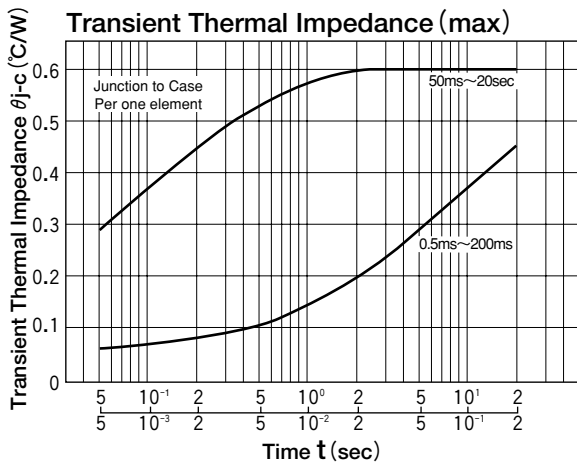
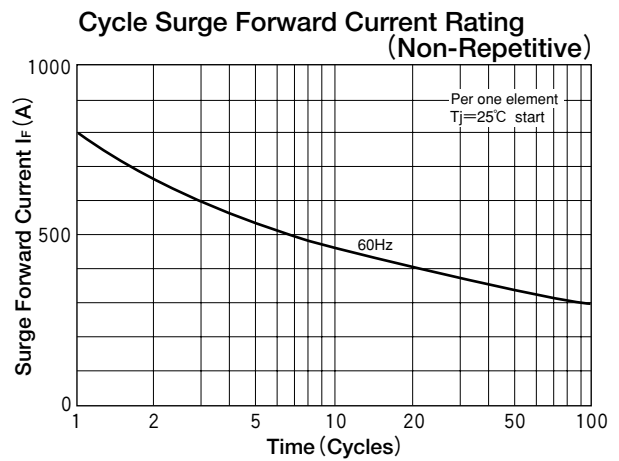
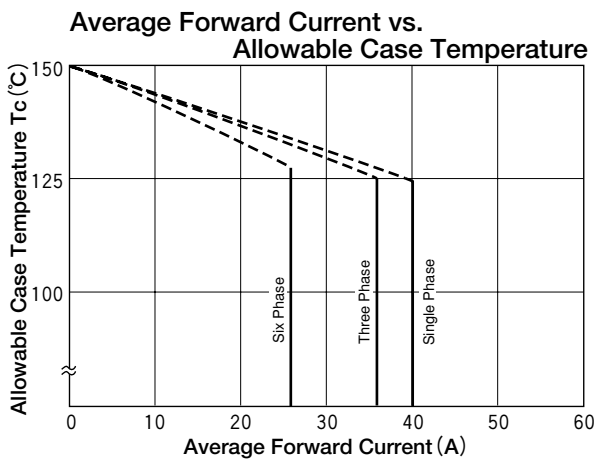
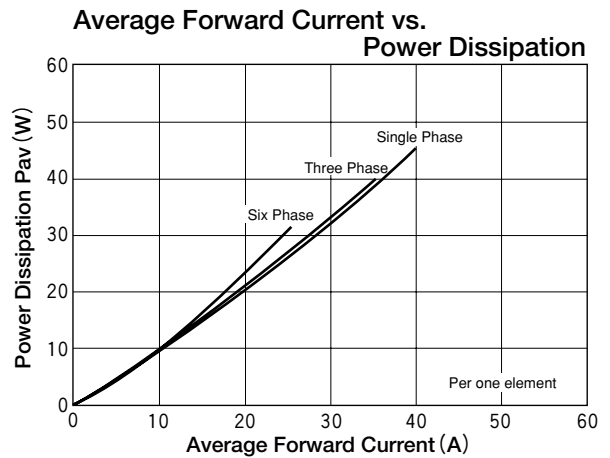
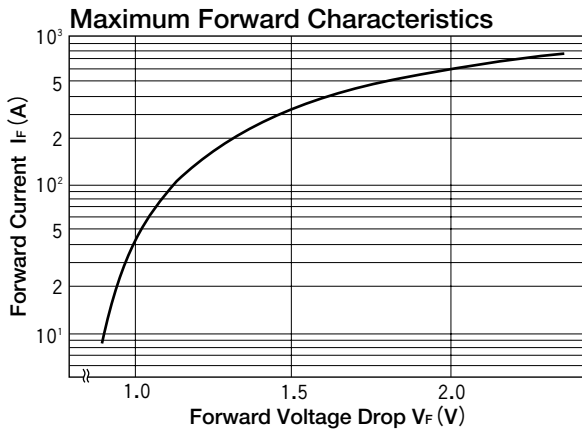

DIODE MODULE

DWF(R)50A30/40

TOP



DWF(R)50A is a non-isolated diode module designed for 3 phase rectification.

- $I_{F(AV)}=50A$, $V_{RRM}=400V$
- Easy Construction with Joint-Cathode (F) Type and Joint-Anode (R) type.
- Non-isolated. (Mounting Base as terminals.)
- High Surge Capability

(Applications)

- Welding Power Supply
- 3 Phase Rectifier

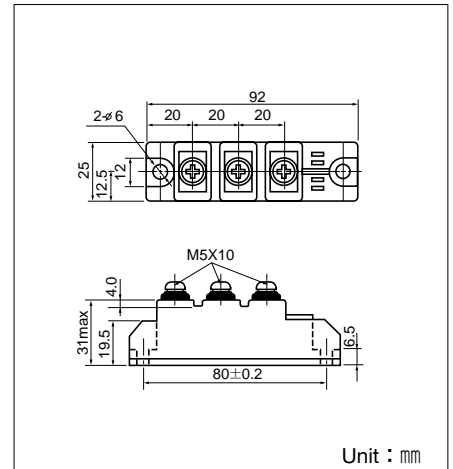
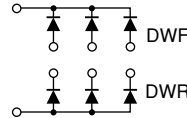

Unit : mm

Maximum Ratings

($T_j=25^\circ C$ unless otherwise specified)

Symbol	Item	Ratings		Unit
		DWF(R)50A30	DWF(R)50A40	
V_{RRM}	Repetitive Peak Reverse Voltage	300	400	V
V_{RSM}	Non-Repetitive Peak Reverse Voltage	360	480	V
$V_{R(DC)}$	D.C. Reverse Voltage	240	320	V

Symbol	Item	Conditions	Ratings	Unit	
$I_{F(AV)}$	Average Forward Current	Single phase, half wave, 180° conduction, $T_c : 122^\circ C$	50	A	
$I_{F(RMS)}$	R.M.S. Forward Current	Single phase, half wave, 180° conduction, $T_c : 122^\circ C$	78	A	
I_{FSM}	Surge Forward Current	$\frac{1}{2}$ cycle, 60Hz, peak value, non-repetitive	1000	A	
I^2t	I^2t	Value for one cycle of surge current	4150	A^2S	
T_j	Operating Junction Temperature		-30 to +150	$^\circ C$	
T_{stg}	Storage Temperature		-30 to +125	$^\circ C$	
	Mounting Torque	Mounting (M5)	Recommended Value 1.5-2.5 (15-25)	2.7 (28)	N·m (kgf·cm)
		Terminal (M5)	Recommended Value 1.5-2.5 (15-25)	2.7 (28)	
	Mass			170	g

Electrical Characteristics

Symbol	Item	Conditions	Ratings	Unit
I_{RRM}	Repetitive Peak Reverse Current, max.	at V_{DRM} , single phase, half wave, $T_j=150^\circ C$	10	mA
V_{FM}	Forward Voltage Drop, max.	Forward current 150A, $T_j=25^\circ C$, Inst. measurement	1.15	V
$R_{th(j-c)}$	Thermal Impedance, max.	Junction to case	0.50	$^\circ C/W$

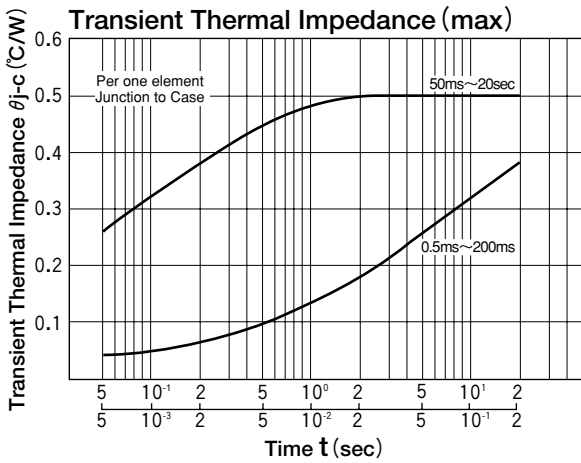
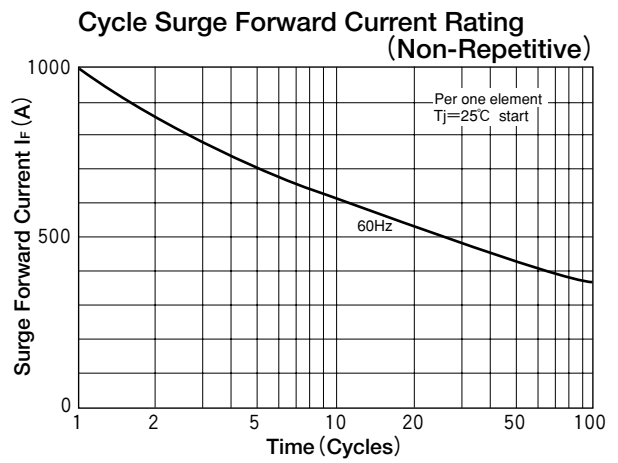
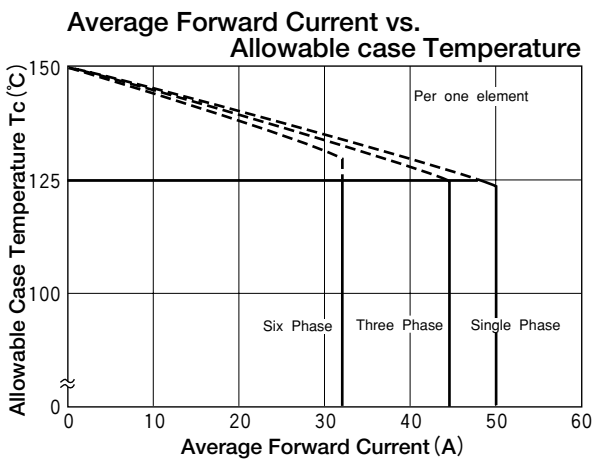
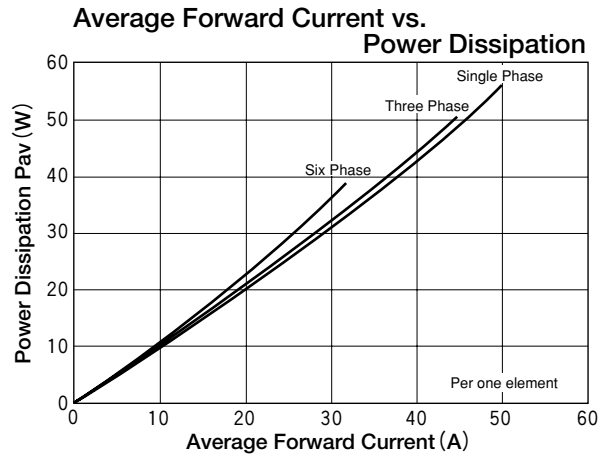
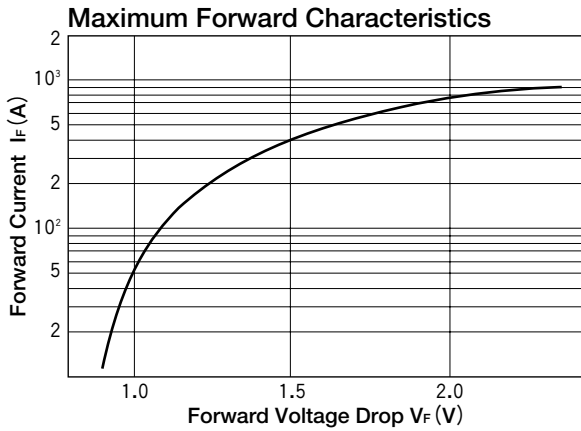

DIODE MODULE

DWF(R)70A30/40

TOP



DWF(R)70A is a non-isolated diode module designed for 3 phase rectification.

- $I_{F(AV)}=70A$, $V_{RRM}=400V$
- Easy Construction with Joint-Cathode (F) Type and Joint-Anode (R) type.
- Non-isolated. (Mounting Base as terminals.)
- High Surge Capability

(Applications)

- Welding Power Supply
- 3 Phase Rectifier

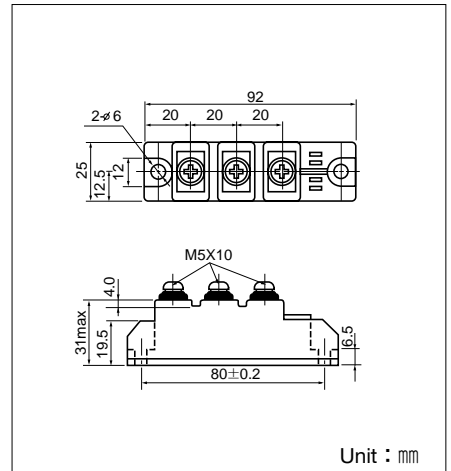
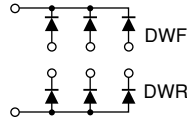

Maximum Ratings

($T_j=25^\circ C$ unless otherwise specified)

Symbol	Item	Ratings		Unit
		DWF(R)70A30	DWF(R)70A40	
V_{RRM}	Repetitive Peak Reverse Voltage	300	400	V
V_{RSM}	Non-Repetitive Peak Reverse Voltage	360	480	V
$V_{R(DC)}$	D.C. Reverse Voltage	240	320	V

Symbol	Item	Conditions	Ratings	Unit	
$I_{F(AV)}$	Average Forward Current	Single phase, half wave, 180° conduction, $T_c : 119^\circ C$	70	A	
$I_{F(RMS)}$	R.M.S. Forward Current	Single phase, half wave, 180° conduction, $T_c : 119^\circ C$	110	A	
I_{FSM}	Surge Forward Current	$\frac{1}{2}$ cycle, 60Hz, peak value, non-repetitive	1400	A	
I^2t	I^2t	Value for one cycle of surge current	8100	A^2S	
T_j	Operating Junction Temperature		-30 to +150	$^\circ C$	
T_{stg}	Storage Temperature		-30 to +125	$^\circ C$	
	Mounting Torque	Mounting (M5)	Recommended Value 1.5-2.5 (15-25)	2.7 (48)	N·m (kgf·cm)
		Terminal (M5)	Recommended Value 1.5-2.5 (15-25)	2.7 (48)	
	Mass			170	g

Electrical Characteristics

Symbol	Item	Conditions	Ratings	Unit
I_{RRM}	Repetitive Peak Reverse Current, max.	at V_{DRM} , single phase, half wave, $T_j=150^\circ C$	12	mA
V_{FM}	Forward Voltage Drop, max.	Forward current 220A, $T_j=25^\circ C$, Inst. measurement	1.15	V
$R_{th(j-c)}$	Thermal Impedance, max.	Junction to case	0.40	$^\circ C/W$

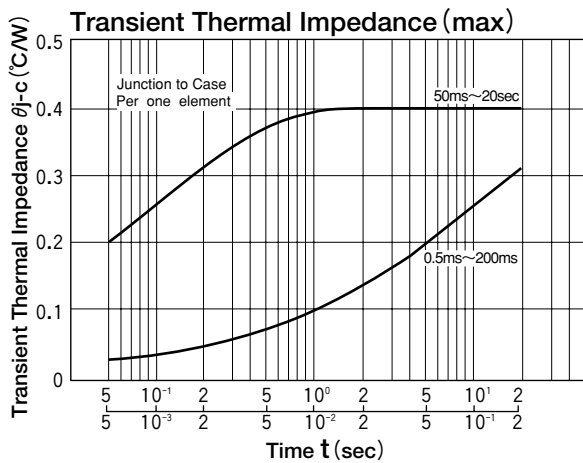
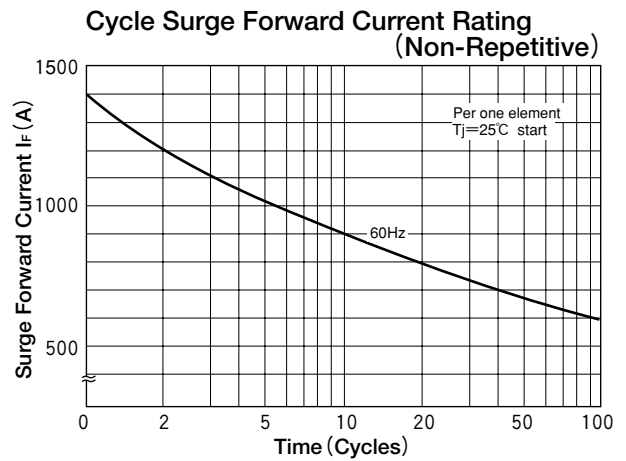
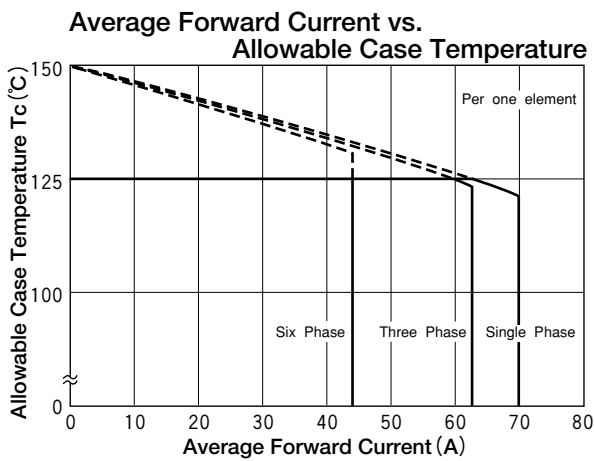
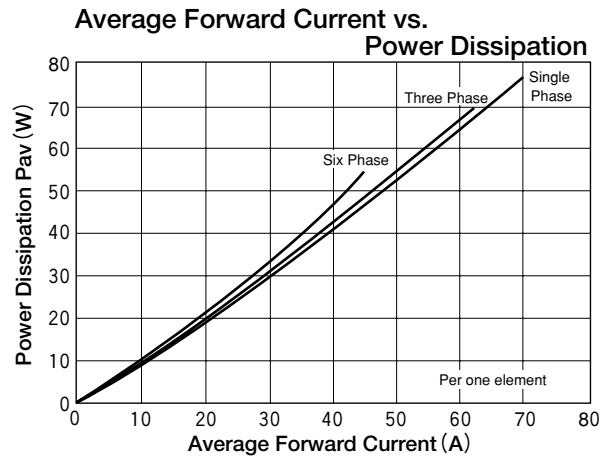
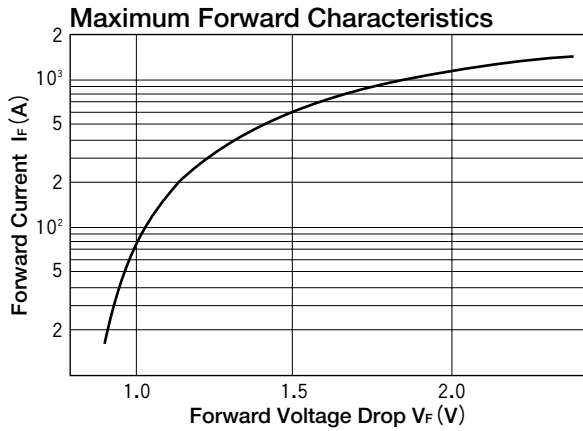

DIODE MODULE

DWF(R)70BB30/40

TOP



Power Diode Module **DWF(W)70BB** is designed for three phase half wave rectification, which has three diodes connected in a three phase bridge configuration. The mounting base of the module is electrically isolated from semiconductor elements for simple heatsink construction. Output DC current is 70Amp ($T_c=106^\circ\text{C}$) Repetitive peak reverse voltage is up to 400V.

- $T_{j\text{Max}}=150^\circ\text{C}$
- Isolated mounting Base
- High reliability by unique glass passivation

(Applications)

AC, DC Motor Drive/AVR/Switching
-for three phase rectification

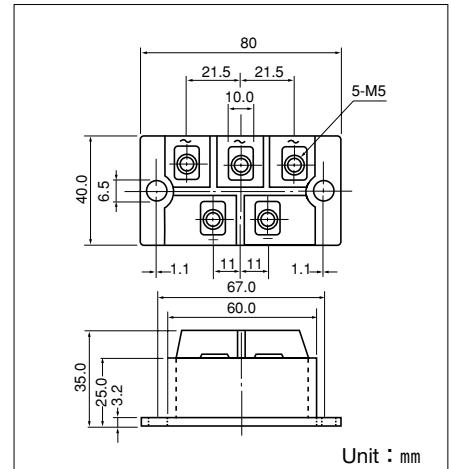
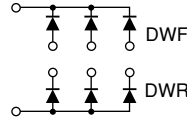

Maximum Ratings

($T_j=25^\circ\text{C}$ unless otherwise specified)

Symbol	Item	Ratings		Unit
		DWF(R)70BB30	DWF(R)70BB40	
V_{RRM}	Repetitive Peak Reverse Voltage	300	400	V
V_{RSM}	Non-Repetitive Peak Reverse Voltage	360	480	V

Symbol	Item	Conditions	Ratings	Unit	
I_D	Average Forward Current (D.C.)	D.C. $T_c : 106^\circ\text{C}$	70	A	
I_{FSM}	Surge Forward Current	1cycle, 60Hz, peak value, non-repetitive	1400	A	
I^2t	I^2t	Value for one cycle of surge current	8100	A^2S	
T_j	Operating Junction Temperature		-40 to +150	$^\circ\text{C}$	
T_{stg}	Storage Temperature		-40 to +125	$^\circ\text{C}$	
V_{ISO}	Isolation Breakdown Voltage (R.M.S.)	A.C. 1minute	2500	V	
	Mounting Torque	Mounting (M5)	Recommended Value 1.5-2.5 (15-25)	2.7 (28)	N·m (kgf·cm)
		Terminal (M5)	Recommended Value 1.5-2.5 (15-25)	2.7 (28)	
	Mass	Typical Value	200	g	

Electrical Characteristics

Symbol	Item	Conditions	Ratings			Unit
			Min.	Typ.	Max.	
I_{RRM}	Repetitive Peak Reverse Current	$T_j=150^\circ\text{C}$ at V_{RRM}			12	mA
V_{FM}	Forward Voltage Drop	$T_j=25^\circ\text{C}$, $I_{FM}=220\text{A}$, Inst. measurement			1.15	V
$R_{th(j-c)}$	Thermal Impedance	Junction to case ($\frac{1}{3}$ MODULE)			0.55	$^\circ\text{C}/\text{W}$

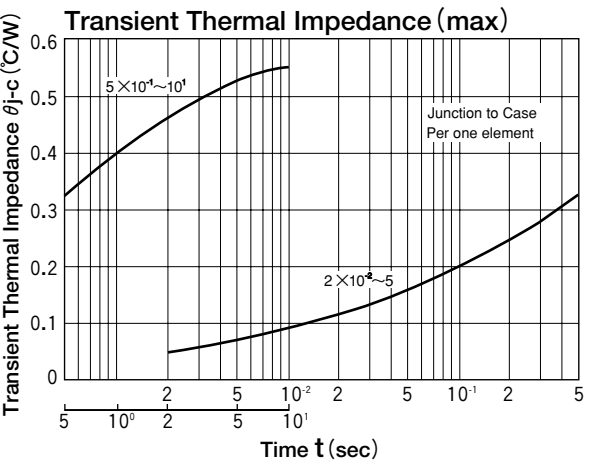
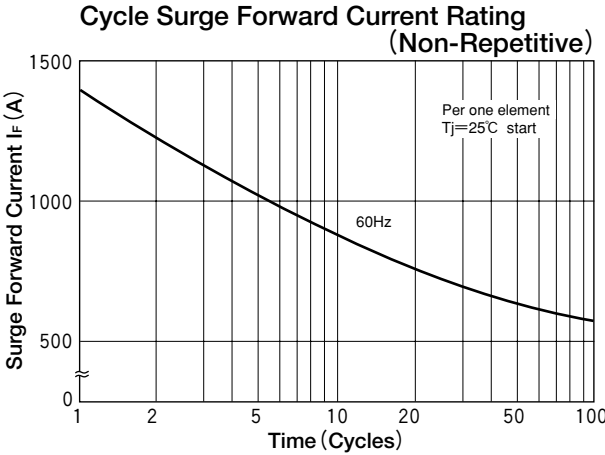
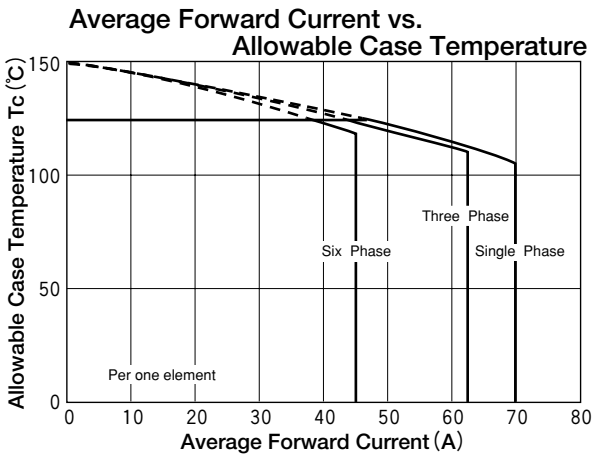
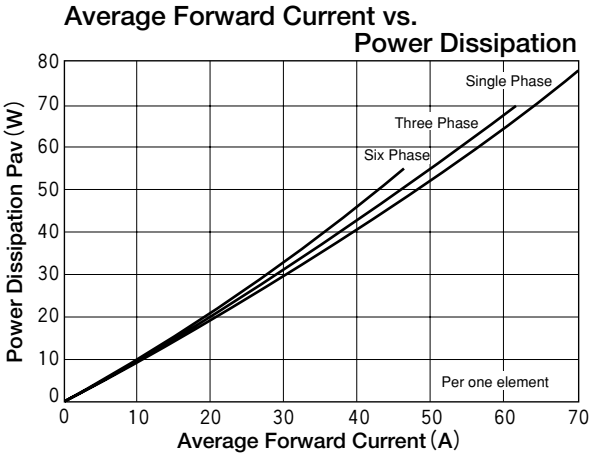
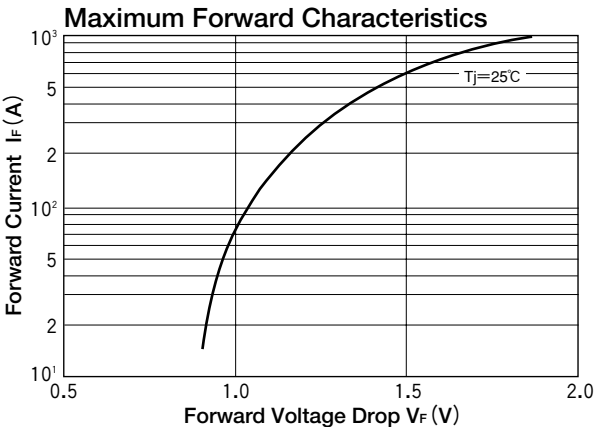

DIODE MODULE

DWF(R)100A30/40

TOP



DWF(R)100A is a non-isolated diode module designed for 3 phase rectification.

- $I_{F(AV)} = 100A$, $V_{RRM} = 400V$
- Easy Construction with Joint-Cathode (F) Type and Joint-Anode (R) type.
- Non-isolated. (Mounting Base as terminals.)
- High Surge Capability

(Applications)

- Welding Power Supply
- 3 Phase Rectifier

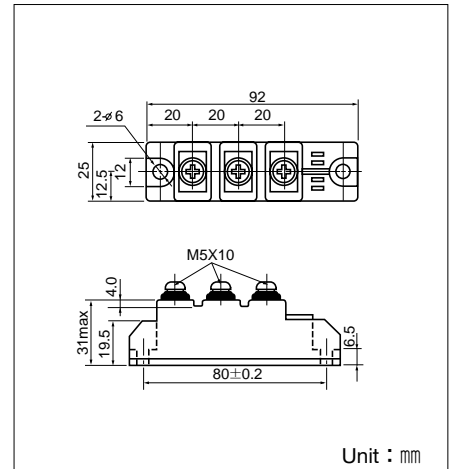
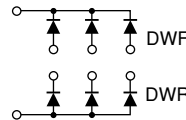

Maximum Ratings

($T_j = 25^\circ C$ unless otherwise specified)

Symbol	Item	Ratings		Unit
		DWF(R)100A30	DWF(R)100A40	
V_{RRM}	Repetitive Peak Reverse Voltage	300	400	V
V_{RSM}	Non-Repetitive Peak Reverse Voltage	360	480	V
$V_{R(DC)}$	D.C. Reverse Voltage	240	320	V

Symbol	Item	Conditions	Ratings	Unit	
$I_{F(AV)}$	Average Forward Current	Single phase, half wave, 180° conduction, $T_c : 122^\circ C$	100	A	
$I_{F(RMS)}$	R.M.S. Forward Current	Single phase, half wave, 180° conduction, $T_c : 122^\circ C$	160	A	
I_{FSM}	Surge Forward Current	$\frac{1}{2}$ cycle, 60Hz, peak value, non-repetitive	2000	A	
I^2t	I^2t	Value for one cycle of surge current	16600	A^2S	
T_j	Operating Junction Temperature		-30 to +150	$^\circ C$	
T_{stg}	Storage Temperature		-30 to +125	$^\circ C$	
	Mounting Torque	Mounting (M5)	Recommended Value 1.5-2.5 (15-25)	2.7 (28)	N·m (kgf·cm)
		Terminal (M5)	Recommended Value 1.5-2.5 (15-25)	2.7 (28)	
	Mass			170	g

Electrical Characteristics

Symbol	Item	Conditions	Ratings	Unit
I_{RRM}	Repetitive Peak Reverse Current, max.	at V_{DRM} , single phase, half wave, $T_j = 150^\circ C$	15	mA
V_{FM}	Forward Voltage Drop, max.	Forward current 300A, $T_j = 25^\circ C$, Inst. measurement	1.15	V
$R_{th(j-c)}$	Thermal Impedance, max.	Junction to case	0.25	$^\circ C/W$

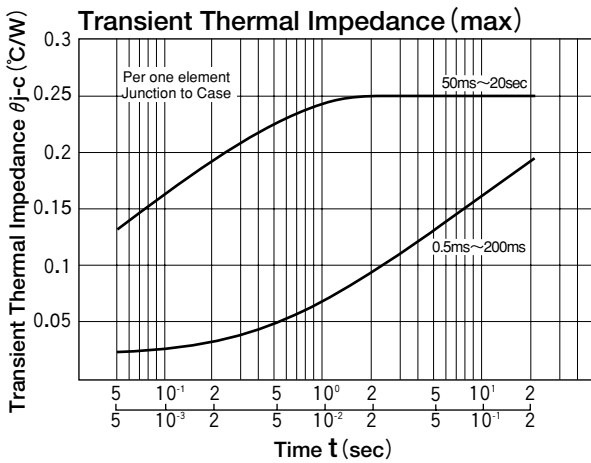
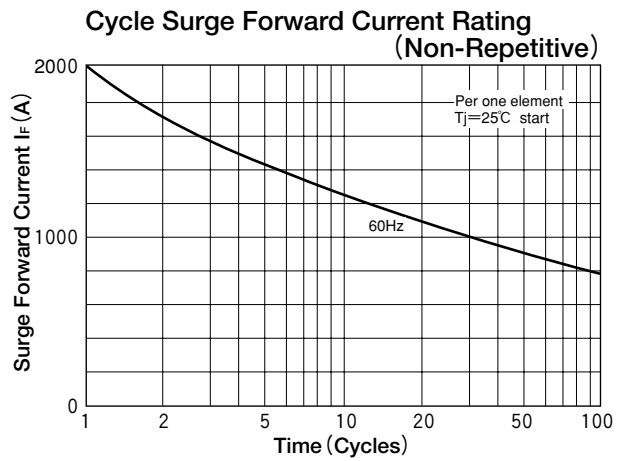
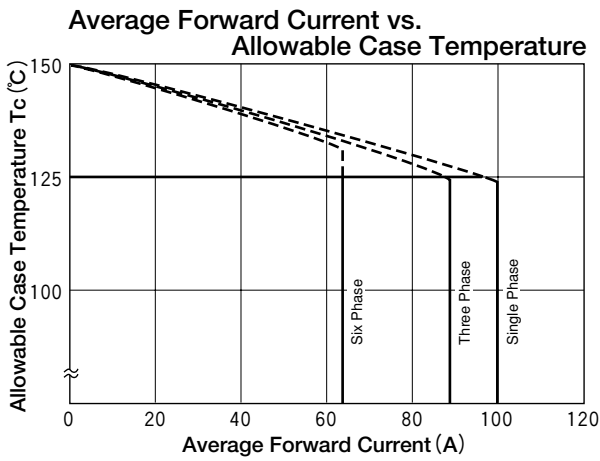
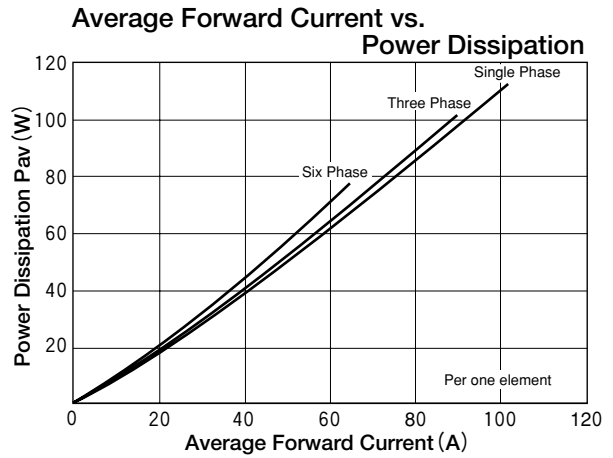
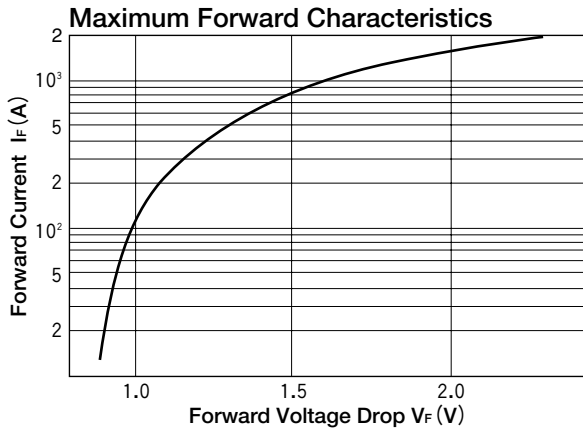

THREE PHASE DIODE+THYRISTOR

DFA50BA80/160

TOP



SanRex Power Module, DFA50BA, is complex isolated module which is designed for rash current circuit.

It contains six diodes connected in a three phase bridge configuration, and a thyristor connected to a direct current line.

- This Module is designed very compactly. Because diode module and thyristor put together.
- This Module is also isolated type between electorode terminal and mounting base. So you can put this Module and other one together in a same fin.

(Application)

- Inverter for AC or DC motor control, Current stabilized power supply, Switching power supply.

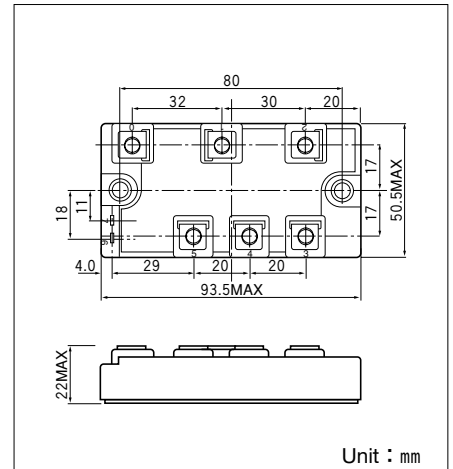
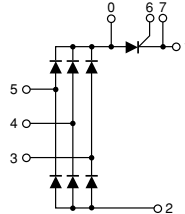

● DIODE

■ Maximum Ratings

(T_j=25°C unless otherwise specified)

Symbol	Item	Ratings		Unit
		DFA50BA80	DFA50BA160	
V _{RRM}	Repetitive Peak Reverse Voltage	800	1600	V
V _{RSM}	Non-Repetitive Peak Reverse Voltage	960	1700	V

Symbol	Item	Conditions	Ratings	Unit	
I _D	Output Current (D.C.)	Three phase full wave, T _c =117°C	50	A	
I _{FSM}	Surge forward current	1cycle, 50/60Hz, peak value, non-repetitive	730/800	A	
T _j	Operating Junction Temperature		-40 to +150	°C	
T _{stg}	Storage Temperature		-40 to +125	°C	
V _{ISO}	Isolation Breakdown Voltage (R.M.S.)	A.C. 1minute	2500	V	
	Mounting Torque	Mounting (M5)	Recommended Value 1.5-2.5 (15-25)	2.7 (28)	N·m (kgf·cm)
		Terminal (M5)	Recommended Value 1.5-2.5 (15-25)	2.7 (28)	
	Mass	Typical Value	150	g	

■ Electrical Characteristics

Symbol	Item	Conditions	Ratings	Unit
I _{RRM}	Repetitive Peak Reverse Current,max.	T _j =150°C, V _R =V _{RRM}	8	mA
V _{FM}	Forward Voltage Drop,max.	T _j =25°C, I _F =50A Inst. measurement	1.30	V
R _{th(j-c)}	Thermal Impedance, max.	Junction to Case (TOTAL)	0.25	°C/W
R _{th(c-f)}	Thermal Impedance, max.	Case to Fin	0.10	°C/W

● THYRISTOR

■ Maximum Ratings

(T_j=25°C unless otherwise specified)

Symbol	Item	Ratings		Unit
		DFA50BA80	DFA50BA160	
V _{RRM}	Repetitive Peak Reverse Voltage	800	1600	V
V _{RSM}	Non-Repetitive Peak Reverse Voltage	960	1700	V
V _{DRM}	Repetitive Peak off-State Voltage	800	1600	V

Symbol	Item	Conditions	Ratings	Unit	
I _{T(AV)}	Average On-State Current	Singl phase half wave. 180° conduction, T _c =85°C	50	A	
I _{TSM}	Surge On-State Current	1 cycle, 50/60Hz, peak value, non-repetitive	730/800	A	
I ² t	I ² t		2660	A ² S	
di/dt	Critical Rate of Rise of On-State Current	I _G =100mA, V _D =1/2V _{DRM} , di _G /dt=0.1A/μs	150	A/μs	
V _{ISO}	Isolation Breakdown Voltage (R.M.S.)	A.C. 1minute	2500	V	
T _j	Operating Junction Temperature		-40 to +135	°C	
T _{stg}	Storage Temperature		-40 to +125	°C	
	Mounting Torque	Mounting (M5)	Recommended Value 1.5-2.5 (15-25)	2.7 (28)	N·m (kgf·cm)
		Terminal (M5)	Recommended Value 1.5-2.5 (15-25)	2.7 (28)	
	Mass	Typical Value		150	g

■ Electrical Characteristics

Symbol	Item	Conditions	Ratings	Unit
I _{DRM}	Repetitive Peak Off-State Current,max.	T _j =135°C, V _D =V _{DRM}	50	mA
I _{RRM}	Repetitive Peak Reverse Current,max.	T _j =135°C, V _D =V _{RRM}	50	mA
V _{TM}	Peak On-State Voltage,max.	T _j =25°C, I _{TM} =50A, Inst. measurement	1.25	V
I _{GT}	Gate Trigger Current,max.	V _D =6V, I _T =1A	70	mA
V _{GT}	Gate Trigger Voltage,max.	V _D =6V, I _T =1A	3	V
dv/dt	Critical Rate of Rise of Off-State Voltage,min.	T _j =125°C, V _D =2/3V _{DRM}	500	V/μs
R _{th(j-c)}	Thermal Impedance, max.	Junction to Case	0.80	°C/W
R _{th(c-f)}	Thermal Impedance, max.	Case to Fin	0.10	°C/W

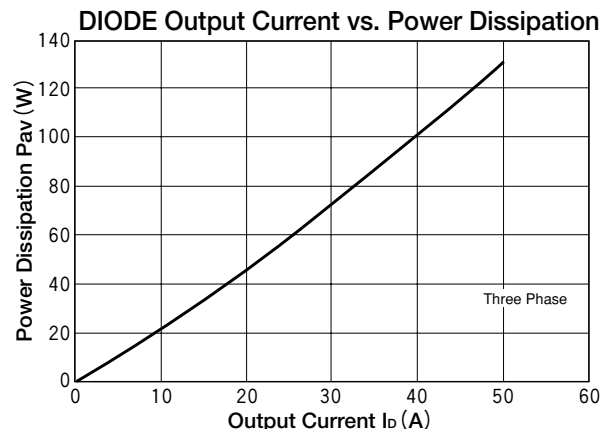
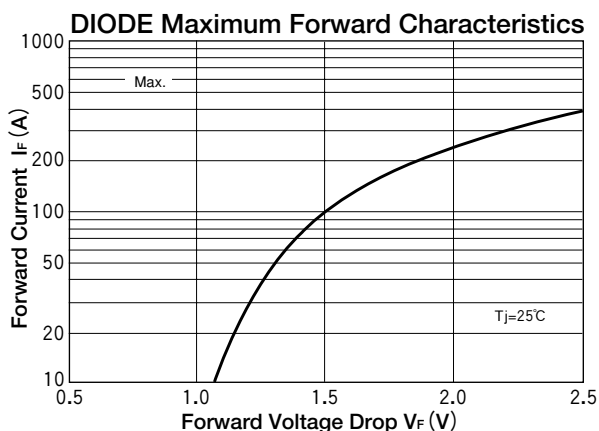

DIODE Output Current vs. Allowable case Temperature

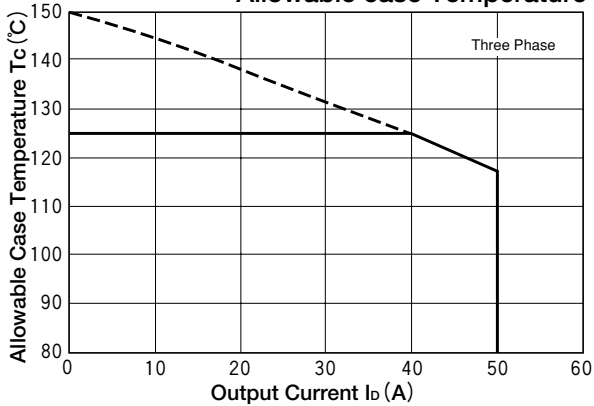

Surge Forward Current Rating (Non-Repetitive)

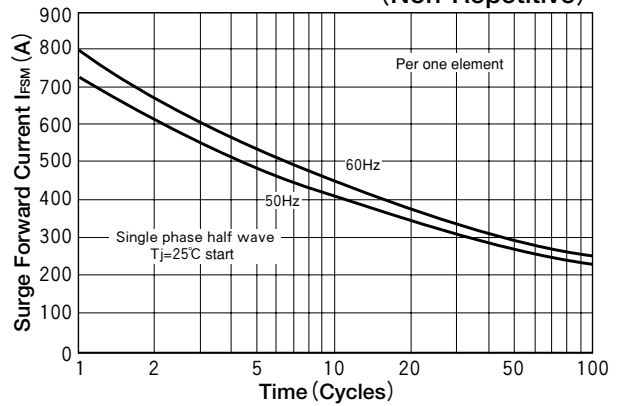

DIODE Transient Thermal Impedance

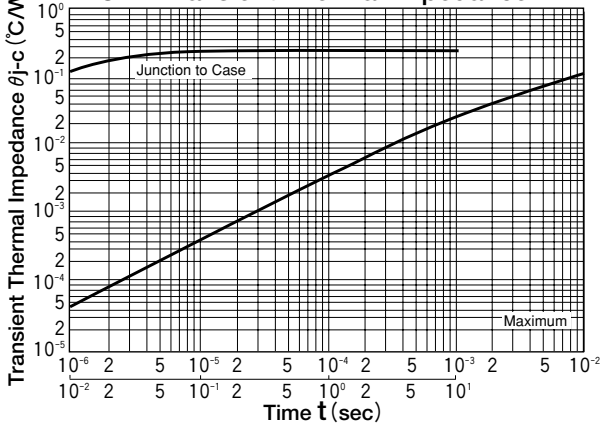

Gate Characteristics

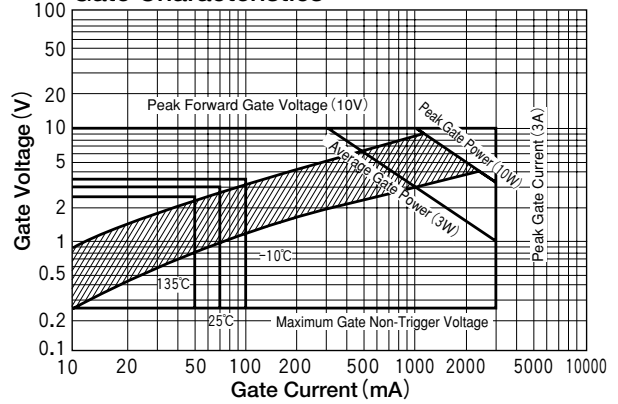

SCR Maximum Forward Characteristics

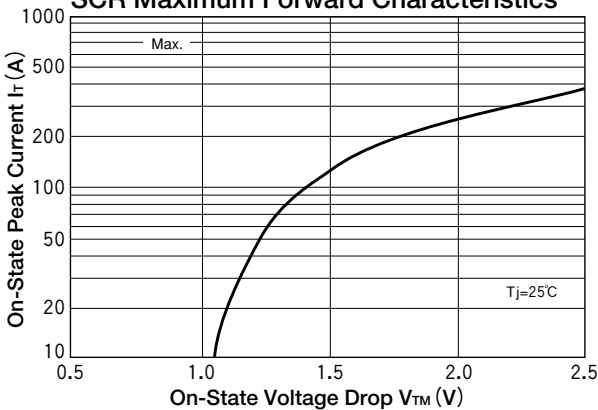

SCR Output Current vs. Power Dissipation

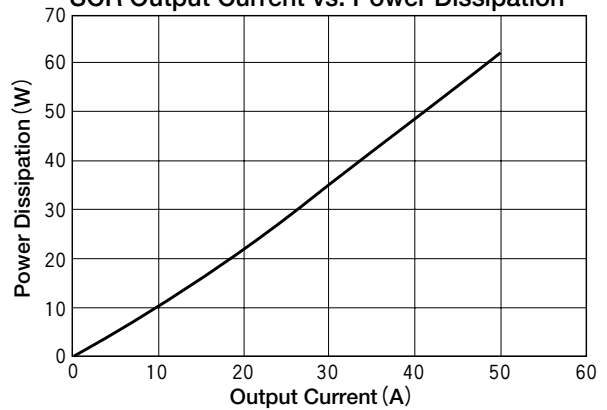

SCR Output Current vs. Maximum Allowable case Temperature

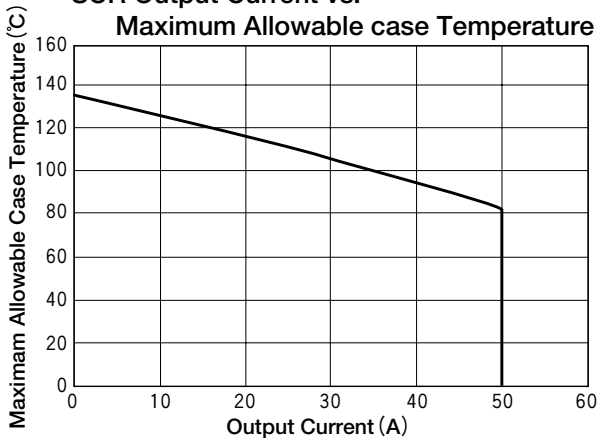

SCR Transient Thermal Impedance

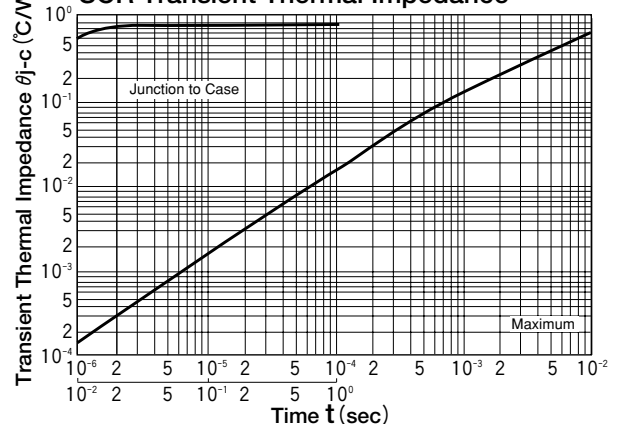

THREE PHASE DIODE+THYRISTOR

DFA75BA80/160

TOP



SanRex Power Module, **DFA75BA**, is complex isolated module which is designed for rash current circuit.

It contains six diodes connected in a three phase bridge configuration, and a thyristor connected to a direct current line.

- This Module is designed very compactly. Because diode module and thyristor put together.
- This Module is also isolated type between electorode terminal and mounting base. So you can put this Module and other one together in a same fin.

(Application)

- Inverter for AC or DC motor control, Current stabilized power supply, Switching power supply.

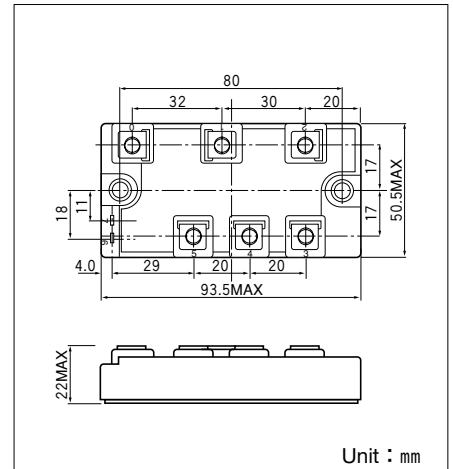
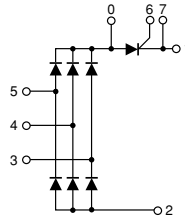

● DIODE

■ Maximum Ratings

(T_j=25°C unless otherwise specified)

Symbol	Item	Ratings		Unit
		DFA75BA80	DFA75BA160	
V _{RRM}	Repetitive Peak Reverse Voltage	800	1600	V
V _{RSM}	Non-Repetitive Peak Reverse Voltage	960	1700	V

Symbol	Item	Conditions	Ratings	Unit	
I _D	Output Current (D.C.)	Three phase full wave, T _c =101°C	75	A	
I _{FSM}	Surge forward current	1cycle, 50/60Hz, peak value, non-repetitive	910/1000	A	
T _j	Operating Junction Temperature		-40 to +150	°C	
T _{stg}	Storage Temperature		-40 to +125	°C	
V _{ISO}	Isolation Breakdown Voltage (R.M.S.)	A.C. 1minute	2500	V	
	Mounting Torque	Mounting (M5)	Recommended Value 1.5-2.5 (15-25)	2.7 (28)	N·m (kgf·cm)
		Terminal (M5)	Recommended Value 1.5-2.5 (15-25)	2.7 (28)	
	Mass	Typical Value	150	g	

■ Electrical Characteristics

Symbol	Item	Conditions	Ratings	Unit
I _{RRM}	Repetitive Peak Reverse Current,max.	T _j =150°C, V _R =V _{RRM}	8	mA
V _{FM}	Forward Voltage Drop,max.	T _j =25°C, I _F =75A, Inst. measurement	1.30	V
R _{th(j-c)}	Thermal Impedance, max.	Junction to Case (TOTAL)	0.25	°C/W
R _{th(c-f)}	Thermal Impedance, max.		0.10	°C/W

● **THYRISTOR**

■ **Maximum Ratings**

(T_j=25°C unless otherwise specified)

Symbol	Item	Ratings		Unit
		DFA75BA80	DFA75BA160	
V _{RRM}	Repetitive Peak Reverse Voltage	800	1600	V
V _{RSM}	Non-Repetitive Peak Reverse Voltage	960	1700	V
V _{DRM}	Repetitive Peak off-State Voltage	800	1600	V

Symbol	Item	Conditions	Ratings	Unit	
I _{T(AV)}	Average On-State Current	Singl phase hulfwave. 180° conduction, T _c =99°C	75	A	
I _{TSM}	Surge On-State Current	1 cycle, 50/60Hz, peak value, non-repetitive	910/1000	A	
I ² t	I ² t		4150	A ² S	
di/dt	Critical Rate of Rise of On-State Current	I _G =100mA, V _D =1/2V _{DRM} , di _G /dt=0.1A/μs	150	A/μs	
V _{ISO}	Isolation Breakdown Voltage (R.M.S.)	A.C. 1minute	2500	V	
T _j	Operating Junction Temperature		-40 to +135	°C	
T _{stg}	Storage Temperature		-40 to +125	°C	
	Mounting Torque	Mounting (M5)	Recommended Value 1.5-2.5 (15-25)	2.7 (28)	N·m (kgf·cm)
		Terminal (M5)	Recommended Value 1.5-2.5 (15-25)	2.7 (28)	
	Mass	Typical Value	150	g	

■ **Electrical Characteristics**

Symbol	Item	Conditions	Ratings	Unit
I _{DRM}	Repetitive Peak Off-State Current,max.	T _j =135°C, V _D =V _{DRM}	60	mA
I _{RRM}	Repetitive Peak Reverse Current,max.	T _j =135°C, V _D =V _{RRM}	60	mA
V _{TM}	Peak On-State Voltage,max.	T _j =25°C, I _{TM} =75A, Inst. measurement	1.20	V
I _{GT}	Gate Trigger Current,max.	V _D =6V, I _T =1A	70	mA
V _{GT}	Gate Trigger Voltage,max.	V _D =6V, I _T =1A	3	V
dv/dt	Critical Rate of Rise of Off-State Voltage,min.	T _j =125°C, V _D =2/3V _{DRM}	500	V/μs
R _{th(j-c)}	Thermal Impedance, max.	Junction to Case	0.40	°C/W
R _{th(c-f)}	Thermal Impedance, max.	Case to Fin	0.10	°C/W

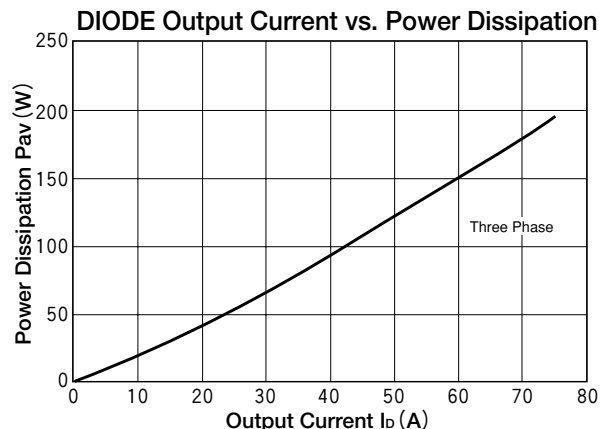
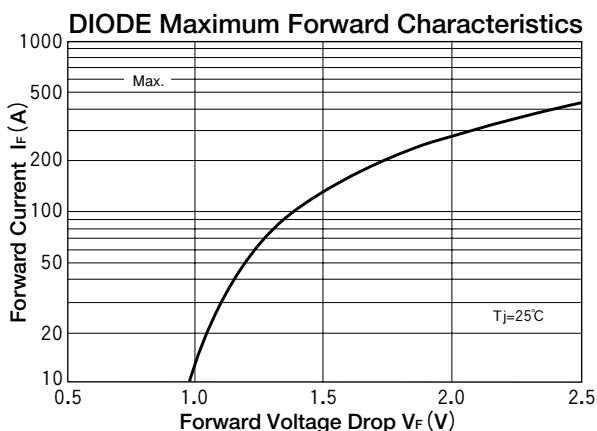

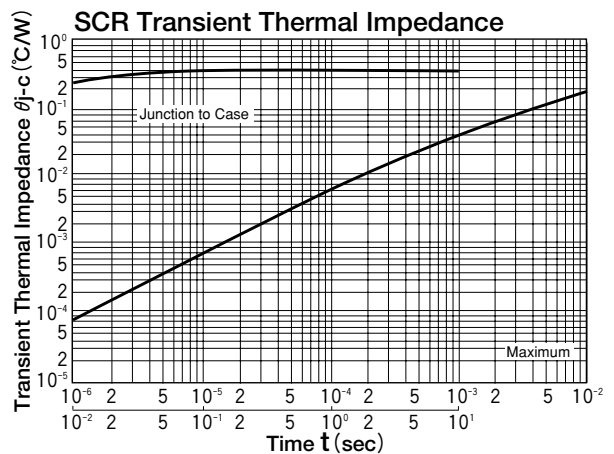
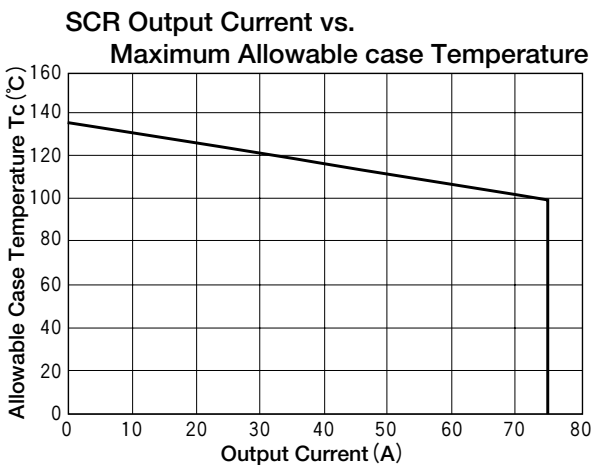
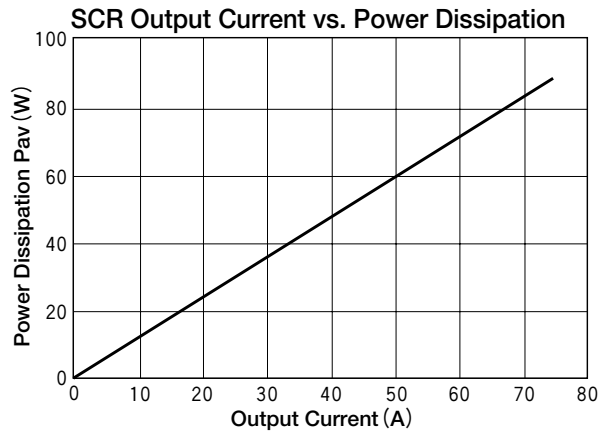
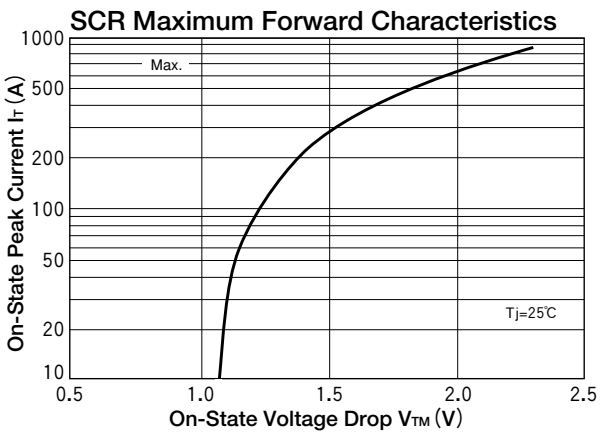
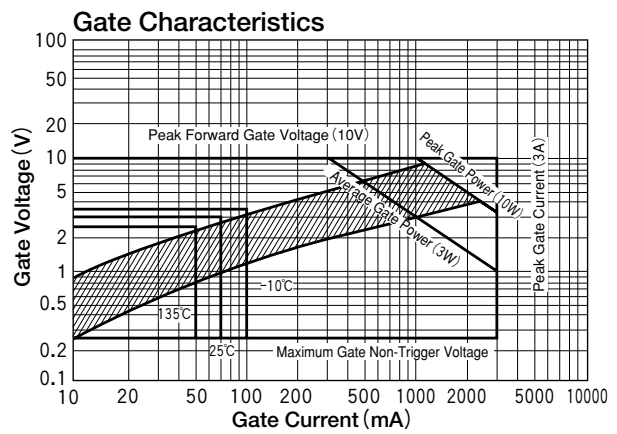
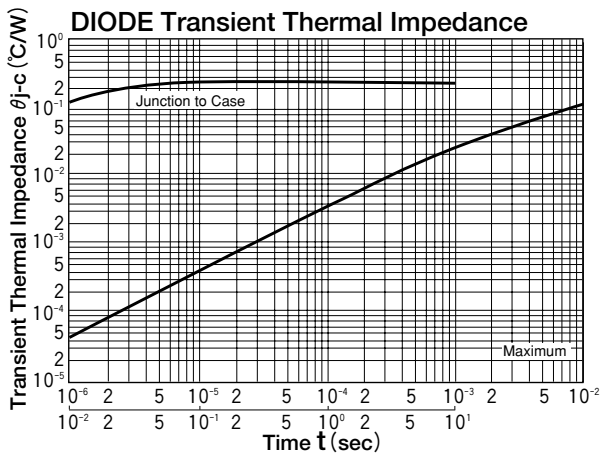
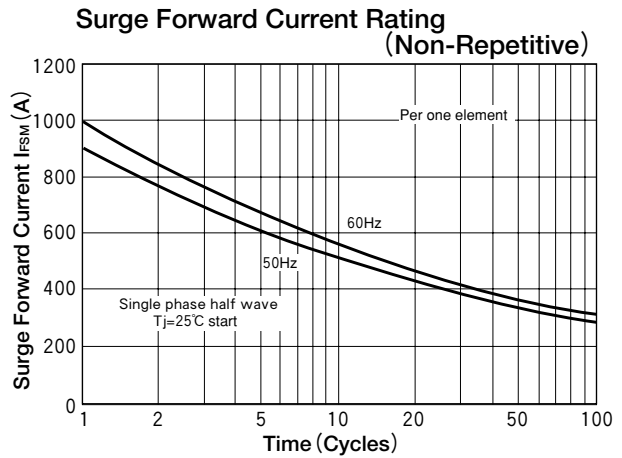
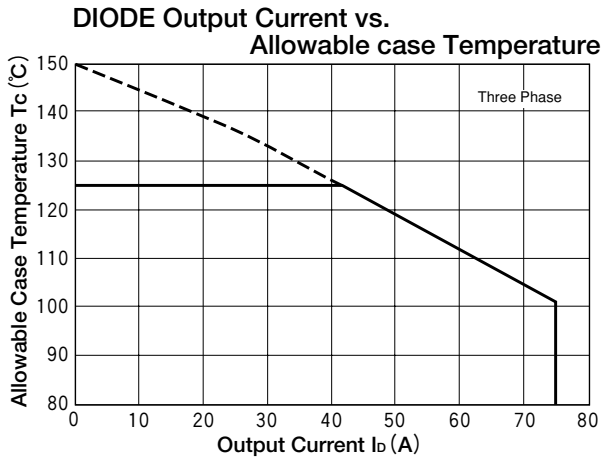

THREE PHASE DIODE+THYRISTOR

DFA100BA80/160

TOP



SanRex Power Module, DFA100BA, is complex isolated module which is designed for rash current circuit.

It contains six diodes connected in a three phase bridge configuration, and a thyristor connected to a direct current line.

- This Module is designed very compactly. Because diode module and thyristor put together.
- This Module is also isolated type between electorode terminal and mounting base. So you can put this Module and other one together in a same fin.

(Application)

- Inverter for AC or DC motor control, Current stabilized power supply, Switching power supply.

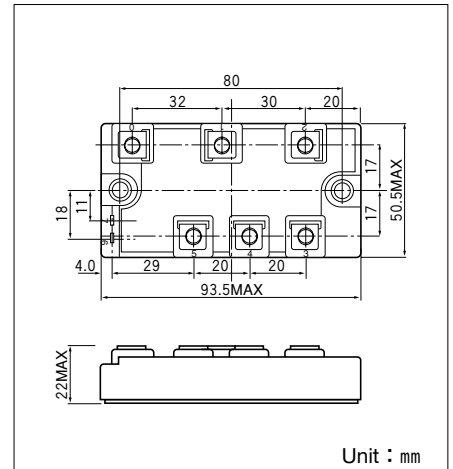
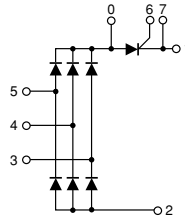

● DIODE

■ Maximum Ratings

(T_j=25°C unless otherwise specified)

Symbol	Item	Ratings		Unit
		DFA100BA80	DFA100BA160	
V _{RRM}	Repetitive Peak Reverse Voltage	800	1600	V
V _{RSM}	Non-Repetitive Peak Reverse Voltage	960	1700	V

Symbol	Item	Conditions	Ratings	Unit	
I _D	Output Current (D.C.)	Three phase full wave, T _c =98°C	100	A	
I _{FSM}	Surge forward current	1 cycle, 50/60Hz, peak value, non-repetitive	1186/1300	A	
T _j	Operating Junction Temperature ^a		-40 to +150	°C	
T _{stg}	Storage Temperature		-40 to +125	°C	
V _{ISO}	Isolation Breakdown Voltage (R.M.S.)	A.C. 1 minute	2500	V	
	Mounting Torque	Mounting (M5)	Recommended Value 1.5-2.5 (15-25)	2.7 (28)	N·m (kgf·cm)
		Terminal (M5)	Recommended Value 1.5-2.5 (15-25)	2.7 (28)	
	Mass	Typical Value	150	g	

■ Electrical Characteristics

Symbol	Item	Conditions	Ratings	Unit
I _{RRM}	Repetitive Peak Reverse Current,max.	T _j =150°C, V _R =V _{RRM}	12	mA
V _{FM}	Forward Voltage Drop,max.	T _j =25°C, I _F =100A, Inst. measurement	1.30	V
R _{th(j-c)}	Thermal Impedance, max.	Junction to Case (TOTAL)	0.20	°C/W
R _{th(c-f)}	Thermal Impedance, max.	Case to Fin	0.10	°C/W

● **THYRISTOR**

■ **Maximum Ratings**

(T_j=25°C unless otherwise specified)

Symbol	Item	Ratings		Unit
		DFA100BA80	DFA100BA160	
V _{RRM}	Repetitive Peak Reverse Voltage	800	1600	V
V _{RSM}	Non-Repetitive Peak Reverse Voltage	960	1700	V
V _{DRM}	Repetitive Peak off-State Voltage	800	1600	V

Symbol	Item	Conditions	Ratings	Unit	
I _{T(AV)}	Average On-State Current	Singl phase half wave. 180° conduction, T _c =92°C	100	A	
I _{TSM}	Surge On-State Current	1 cycle, 50/60Hz, peak value, non-repetitive	1186/1300	A	
I ² t	I ² t		7030	A ² S	
di/dt	Critical Rate of Rise of On-State Current	I _G =100mA, V _D =1/2V _{DRM} , di _G /dt=0.1A/μs	150	A/μs	
V _{ISO}	Isolation Breakdown Voltage (R.M.S.)	A.C. 1minute	2500	V	
T _j	Operating Junction Temperature		-40 to +135	°C	
T _{stg}	Storage Temperature		-40 to +125	°C	
	Mounting Torque	Mounting (M5)	Recommended Value 1.5-2.5 (15-25)	2.7 (28)	N·m (kgf·cm)
		Terminals (M5)	Recommended Value 1.5-2.5 (15-25)	2.7 (28)	
	Mass	Typical Value	150	g	

■ **Electrical Characteristics**

Symbol	Item	Conditions	Ratings	Unit
I _{DRM}	Repetitive Peak Off-State Current,max.	T _j =135°C, V _D =V _{DRM}	70	mA
I _{RRM}	Repetitive Peak Reverse Current,max.	T _j =135°C, V _D =V _{RRM}	70	mA
V _{TM}	Peak On-State Voltage,max.	T _j =25°C, I _{TM} =100A, Inst. measurement	1.20	V
I _{GT}	Gate Trigger Current,max.	V _D =6V, I _T =1A	70	mA
V _{GT}	Gate Trigger Voltage,max.	V _D =6V, I _T =1A	3	V
dv/dt	Critical Rate of Rise of Off-State Voltage,min.	T _j =125°C, V _D =2/3V _{DRM}	500	V/μs
R _{th(j-c)}	Thermal Impedance, max.	Junction to Case	0.36	°C/W
R _{th(c-f)}	Thermal Impedance, max.	Case to Fin	0.10	°C/W

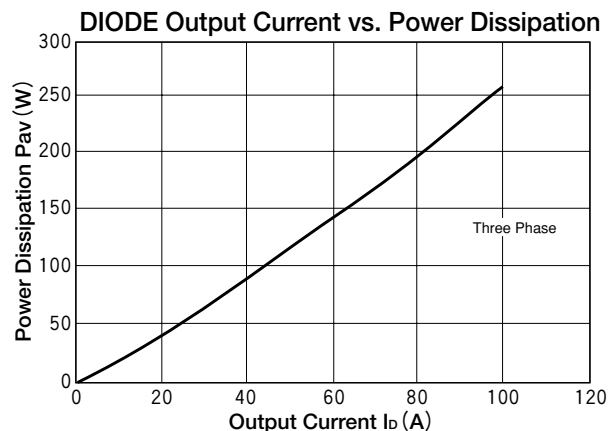
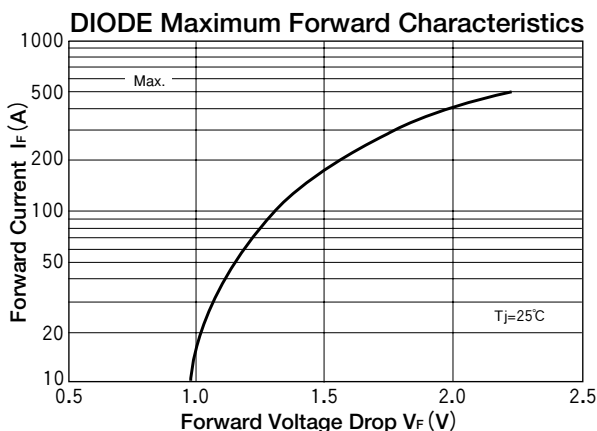

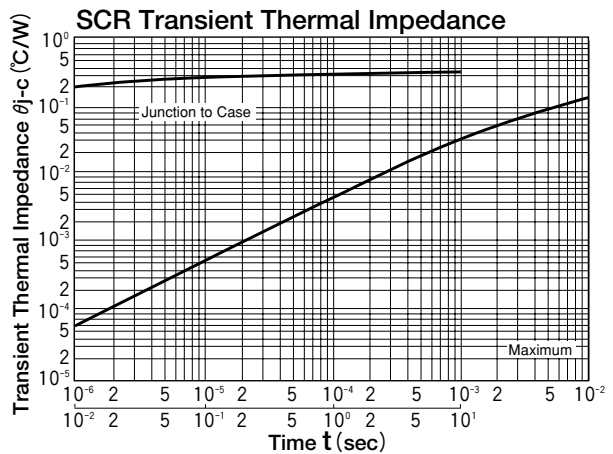
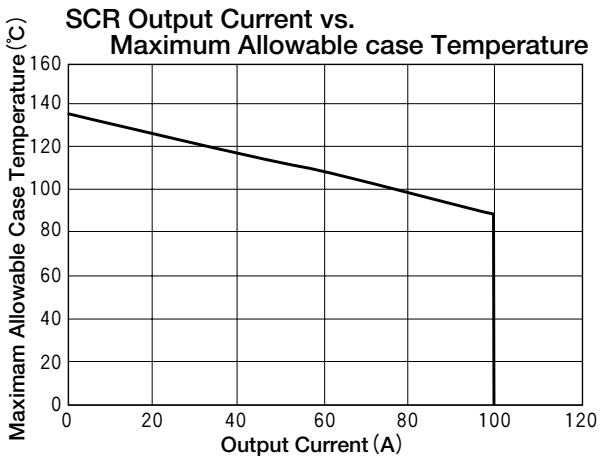
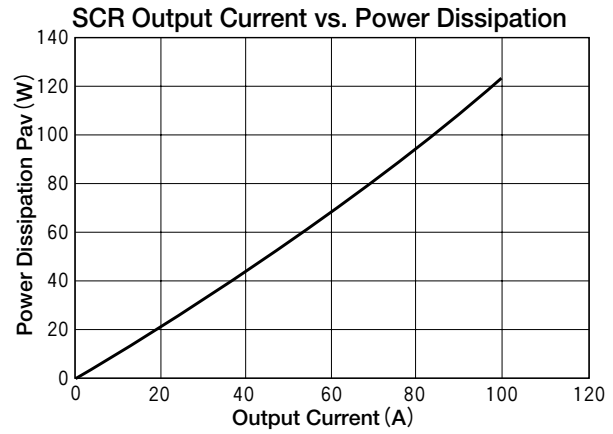
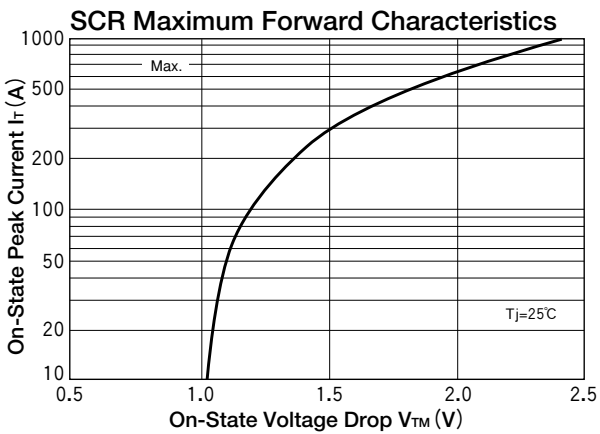
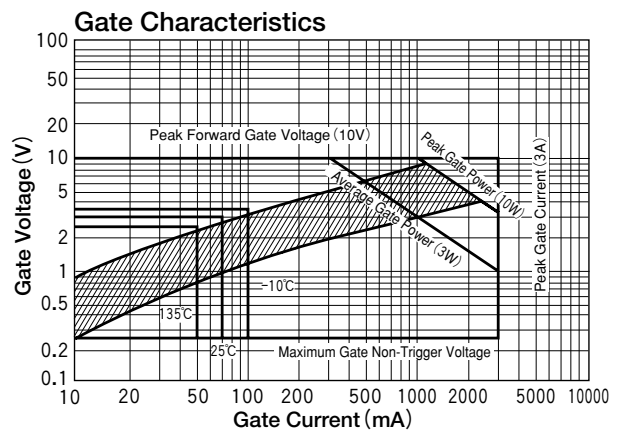
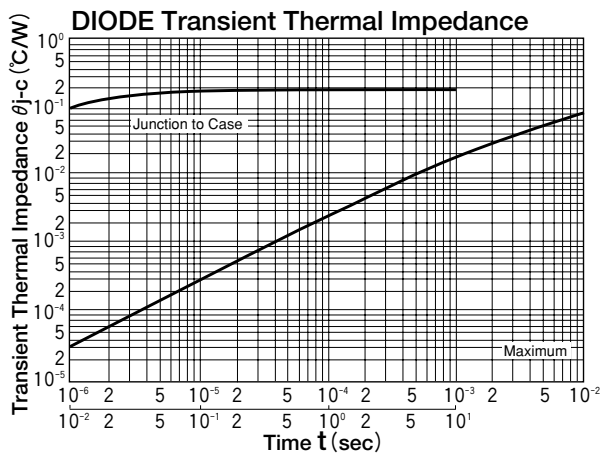
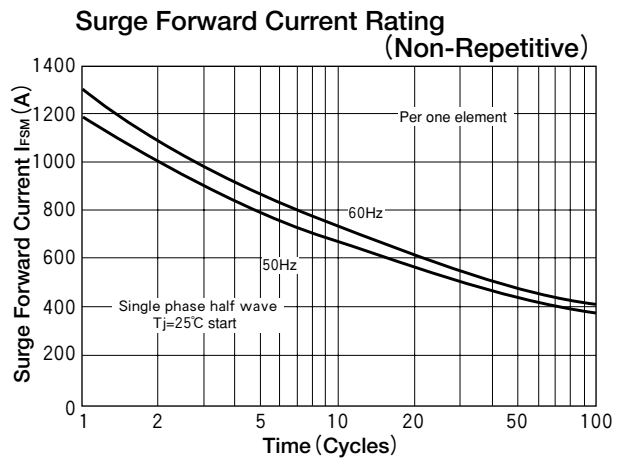
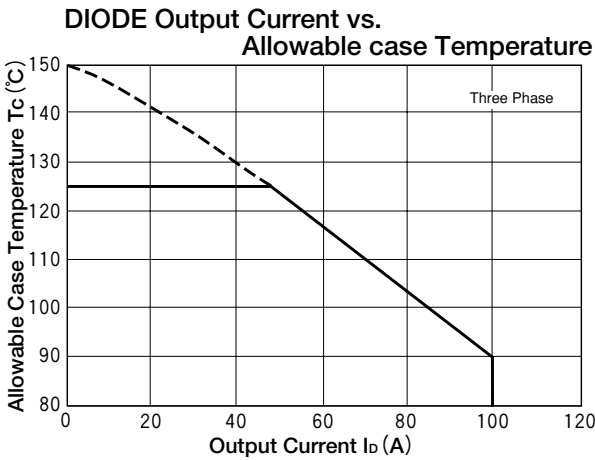

THREE PHASE DIODE+THYRISTOR

DFA150AA80/160



UL;E76102 (M)

SanRex Power Module, DFA150AA, is complex isolated module which is designed for rash current circuit.

It contains six diodes connected in a three phase bridge configuration, and a thyristor connected to a direct current line.

- This Module is designed very compactly. Because diode module and thyristor put together.
- This Module is also isolated type between electorode terminal and mounting base. So you can put this Module and other one together in a same fin.

(Application)

- Inverter for AC or DC motor control, Current stabilized power supply, Switching power supply.

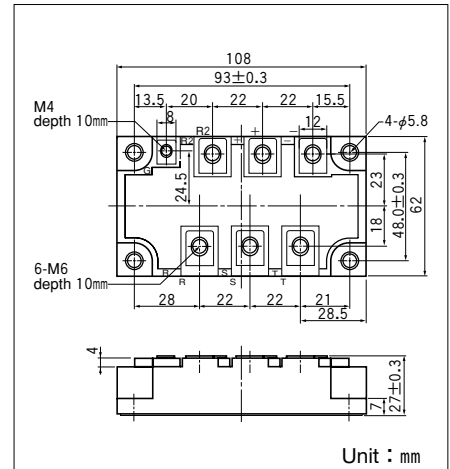
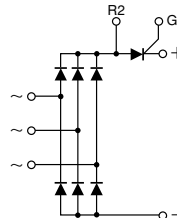

Unit : mm

● DIODE

■ Maximum Ratings

(T_j=25°C unless otherwise specified)

Symbol	Item	Ratings		Unit
		DFA150AA80	DFA150AA160	
V _{RRM}	Repetitive Peak Reverse Voltage	800	1600	V
V _{RSM}	Non-Repetitive Peak Reverse Voltage	960	1700	V

Symbol	Item	Conditions	Ratings	Unit	
I _D	Output Current (D.C.)	Three phase full wave, T _c =93°C	150	A	
I _{FSM}	Surge forward current	1 cycle, 50/60Hz, peak value, non-repetitive	1460/1600	A	
T _j	Operating Junction Temperature		-40 to +150	°C	
T _{stg}	Storage Temperature		-40 to +125	°C	
V _{ISO}	Isolation Breakdown Voltage (R.M.S.)	A.C. 1minute	2500	V	
	Mounting Torque	Mounting (M5)	Recommended Value 1.5-2.5 (15-25)	2.7 (28)	N·m (kgf·cm)
		Terminal (M6)	Recommended Value 2.5-3.9 (25-40)	4.7 (48)	
		Terminal (M4)	Recommended Value 1.0-1.4 (10-14)	1.5 (15)	
	Mass	Typical Value	460	g	

■ Electrical Characteristics

Symbol	Item	Conditions	Ratings	Unit
I _{RRM}	Repetitive Peak Reverse Current,max.	T _j =150°C, V _R =V _{RRM}	15	mA
V _{FM}	Forward Voltage Drop,max.	I _F =150A, Inst. measurement	1.35	V
R _{th(j-c)}	Thermal Impedance, max.	Junction to Case (TOTAL)	0.14	°C/W
R _{th(c-f)}	Thermal Impedance, max.	Case to fin	0.07	°C/W

● **THYRISTOR**

■ **Maximum Ratings**

(T_j=25°C unless otherwise specified)

Symbol	Item	Ratings		Unit
		DFA150AA80	DFA150AA160	
V _{RRM}	Repetitive Peak Reverse Voltage	800	1600	V
V _{RSM}	Non-Repetitive Peak Reverse Voltage	960	1700	V
V _{DRM}	Repetitive Peak off-State Voltage	800	1600	V

Symbol	Item	Conditions	Ratings	Unit	
I _{T(AV)}	Average On-State Current	Singl phase half wave. 180° conduction, T _c =93°C	150	A	
I _{TSM}	Surge On-State Current	1 cycle, 50/60Hz, peak value, non-repetitive	1460/1600	A	
I ² t	I ² t (for fusing)		10670	A ² S	
di/dt	Critical Rate of Rise of On-State Current	I _G =100mA, V _D =½V _{DRM} , di _G /dt=0.1A/μs	150	A/μs	
V _{ISO}	Isolation Breakdown Voltage (R.M.S.)	A.C. 1minute	2500	V	
T _j	Operating Junction Temperature		-40 to +135	°C	
T _{stg}	Storage Temperature		-40 to +125	°C	
	Mounting Torque	Mounting (M5)	Recommended Value 1.5-2.5 (15-25)	2.7 (28)	N·m (kgf·cm)
		Terminal (M6)	Recommended Value 2.5-3.9 (25-40)	4.7 (48)	
		Terminal (M4)	Recommended Value 1.0-1.4 (10-14)	1.5 (15)	
	Mass	Typical Value	460	g	

■ **Electrical Characteristics**

Symbol	Item	Conditions	Ratings	Unit
I _{DRM}	Repetitive Peak Off-State Current,max.	T _j =135°C, V _D =V _{DRM}	100	mA
I _{RRM}	Repetitive Peak Reverse Current,max.	T _j =135°C, V _D =V _{RRM}	100	mA
V _{TM}	Peak On-State Voltage,max.	T _j =25°C, I _{TM} =150A, , Inst. measurement	1.35	V
I _{GT}	Gate Trigger Current,max.	T _j =25°C, V _D =6V, I _T =1A	70	mA
V _{GT}	Gate Trigger Voltage,max.	T _j =25°C, V _D =6V, I _T =1A	3	V
dv/dt	Critical Rate of Rise of Off-State Voltage,min.	T _j =125°C, V _D =⅔V _{DRM}	500	V/μs
R _{th(j-c)}	Thermal Impedance, max.	Junction to Case	0.21	°C/W
R _{th(c-f)}	Thermal Impedance, max.	Case to fin	0.07	°C/W

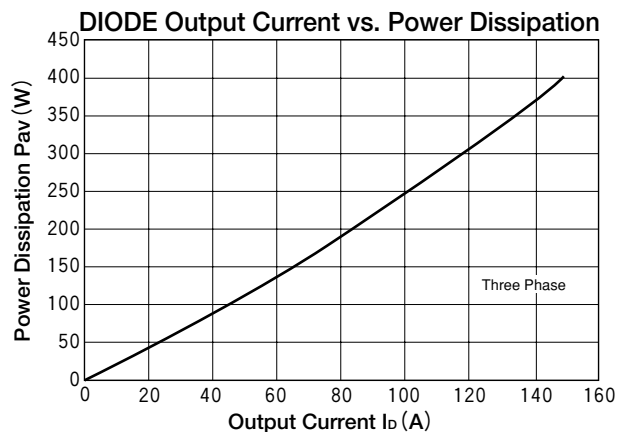
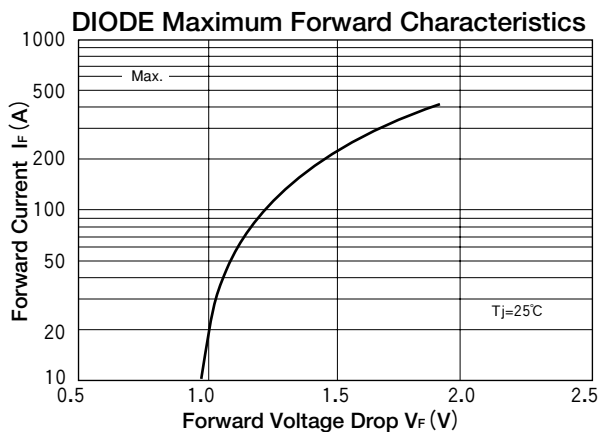

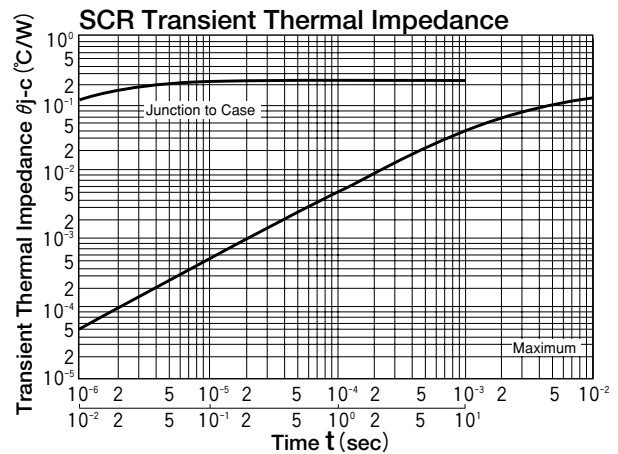
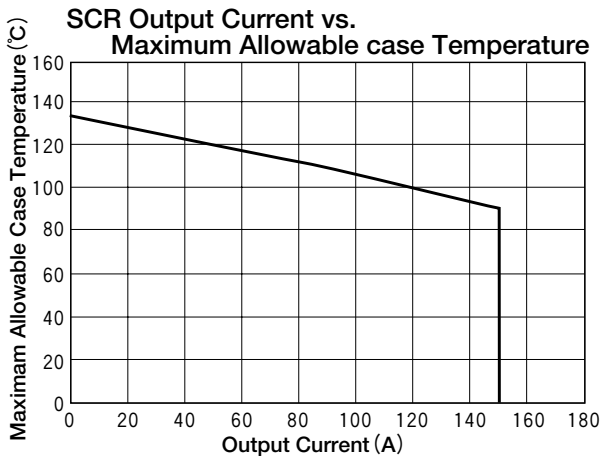
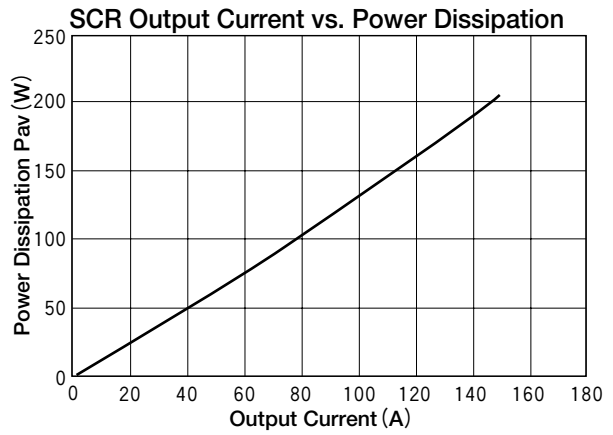
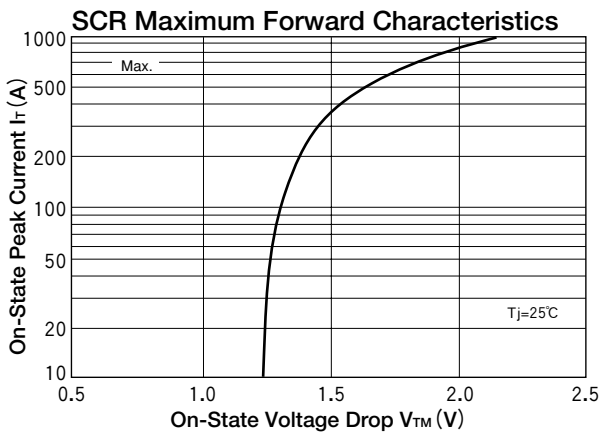
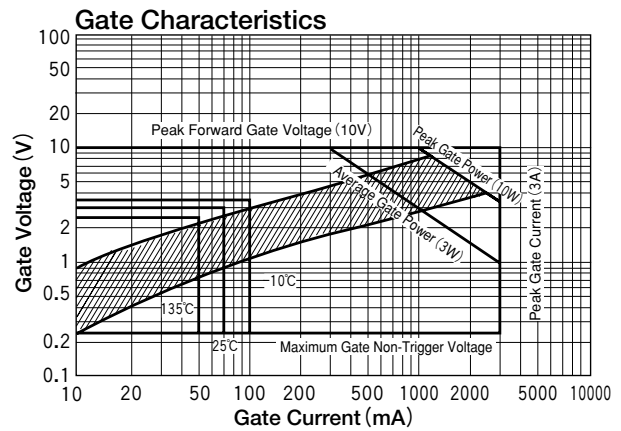
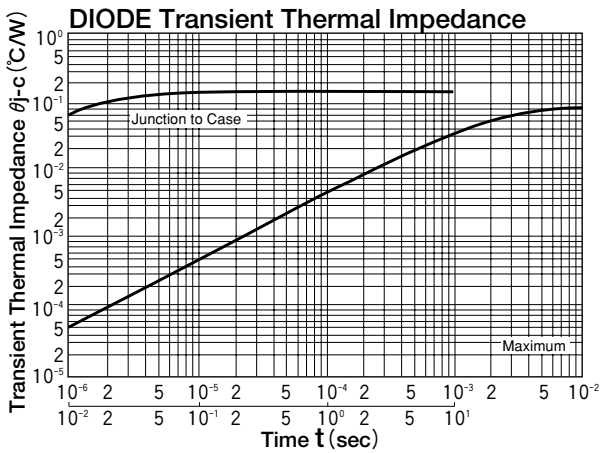
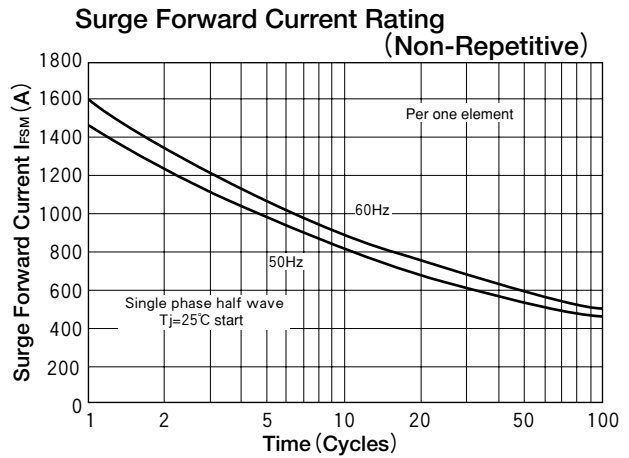
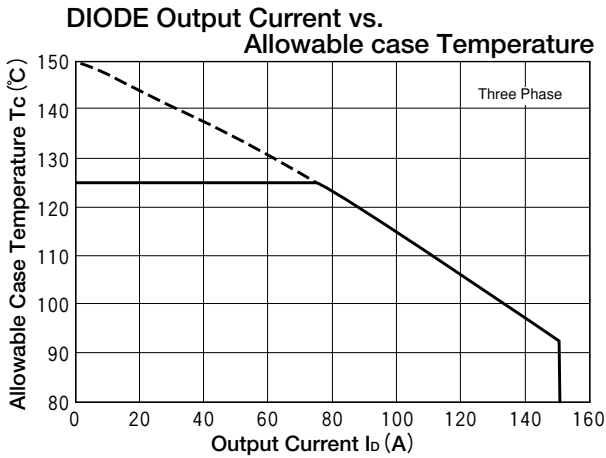

THREE PHASE DIODE+THYRISTOR

DFA200AA80/160



UL;E76102 (M)

SanRex Power Module, DFA200AA, is complex isolated module which is designed for rash current circuit.

It contains six diodes connected in a three phase bridge configuration, and a thyristor connected to a direct current line.

- This Module is designed very compactly. Because diode module and thyristor put together.
- This Module is also isolated type between electorode terminal and mounting base. So you can put this Module and other one together in a same fin.

(Application)

- Inverter for AC or DC motor control, Current stabilized power supply, Switching power supply.

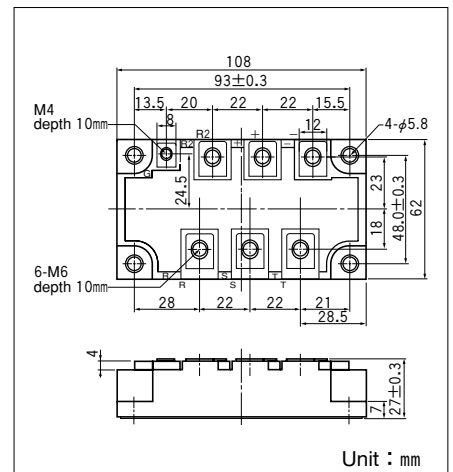
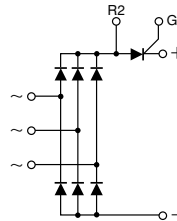

● DIODE

■ Mximum Ratings

(T_j=25°C unless otherwise specified)

Symbol	Item	Ratings		Unit
		DFA200AA80	DFA200AA160	
V _{RRM}	Repetitive Peak Reverse Voltage	800	1600	V
V _{RSM}	Non-Repetitive Peak Reverse Voltage	960	1700	V

Symbol	Item	Conditions	Ratings	Unit
I _D	Output Current (D.C.)	Three phase full wave, T _c =96°C	200	A
I _{FSM}	Surge forward current	1 cycle, 50/60Hz, peak value, non-repetitive	1850/2000	kA
T _j	Operating Junction Temperature		-30 to +150	°C
T _{stg}	Storage Temperature		-30 to +135	°C
V _{ISO}	Isolation Breakdown Voltage (R.M.S.)	A.C. 1minute	2500	V
	Mounting Torque	Mounting (M5)	Recommended Value 1.5-2.5 (15-25)	2.7 (28)
		Terminal (M6)	Recommended Value 2.5-3.9 (25-40)	4.7 (48)
		Terminal (M4)	Recommended Value 1.0-1.4 (10-14)	1.5 (15)
	Mass	Typical Value	460	g

■ Electrical Characteristics

Symbol	Item	Conditions	Ratings	Unit
I _{RRM}	Repetitive Peak Reverse Current,max.	T _j =150°C, V _R =V _{RRM}	20	mA
V _{FM}	Forward Voltage Drop,max.	I _F =200A Inst. measurement	1.35	V
R _{th(j-c)}	Thermal Impedance, max.	Junction to Case (TOTAL)	0.10	°C/W

● **THYRISTOR**

■ **Maximum Ratings**

(T_j=25°C unless otherwise specified)

Symbol	Item	Ratings		Unit
		DFA200AA80	DFA200AA160	
V _{RRM}	Repetitive Peak Reverse Voltage	800	1600	V
V _{RSM}	Non-Repetitive Peak Reverse Voltage	960	1700	V
V _{DRM}	Repetitive Peak Off-State Voltage	800	1600	V

Symbol	Item	Conditions	Ratings	Unit
I _{T(AV)}	Average On-State Current	Singl phase half wave. 180° conduction, T _c =93°C	200	A
I _{TSM}	Surge On-State Current	½ cycle, 50/60Hz, peak value, non-repetitive	1850/2000	A
I ² t	I ² t (for fusing)	Value for one of surge current	17000	A ² S
di/dt	Critical Rate of Rise of On-State Current	I _G =100mA, V _D =½V _{DRM} , di _G /dt=0.1A/μs	200	A/μs
V _{ISO}	Isolation Breakdown Voltage (R.M.S.)	A.C. 1minute	2500	V
T _j	Operating Junction Temperature	T _j =125°C~135°C	-30 to +135	°C
T _{stg}	Storage Temperature		-30 to +135	°C
	Mounting Torque	Mounting (M5)	Recommended Value 1.5-2.5 (15-25)	2.7 (28)
		Terminal (M6)	Recommended Value 2.5-3.9 (15-25)	4.7 (48)
		Terminal (M4)	Recommended Value 1.0-1.4 (15-25)	1.5 (15)
	Mass	Typical Value	460	g

■ **Electrical Characteristics**

Symbol	Item	Conditions	Ratings	Unit
I _{DRM}	Repetitive Peak off-State Current,max.	T _j =135°C, V _D =V _{DRM}	50	mA
I _{RRM}	Repetitive Peak Reverse Current,max.	T _j =135°C, V _D =V _{DRM}	50	mA
V _{TM}	Peak on-State Voltagea,max.	I _T =200A Inst. measurement	1.15	V
I _{GT}	Gate Trigger Current,max.	V _D =6V, I _T =1A	100	mA
V _{GT}	Gate Trigger Voltage,max.	V _D =6V, I _T =1A	3	V
dv/dt	Critical Rate of off-State Voltage,min.	T _j =125°C, V _D =⅔V _{DRM}	500	V/μs
R _{th(j-c)}	Thermal Impedance, max.	Junction to Case	0.18	°C/W

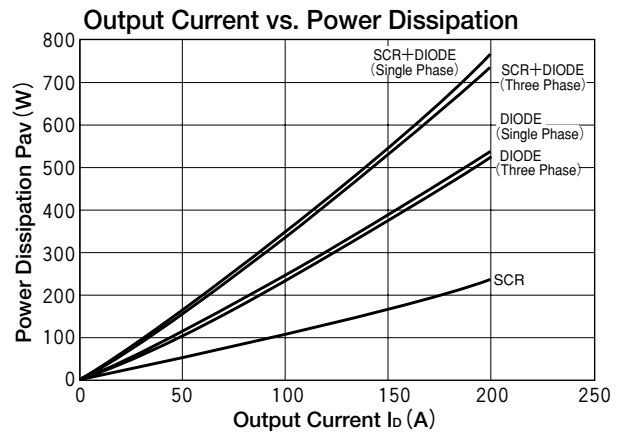
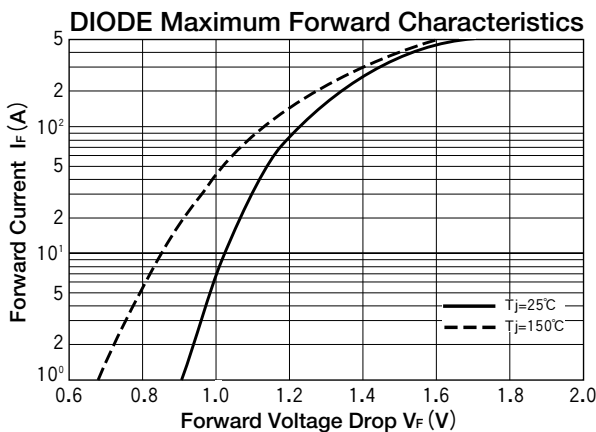

Output Current vs. Allowable case Temperature

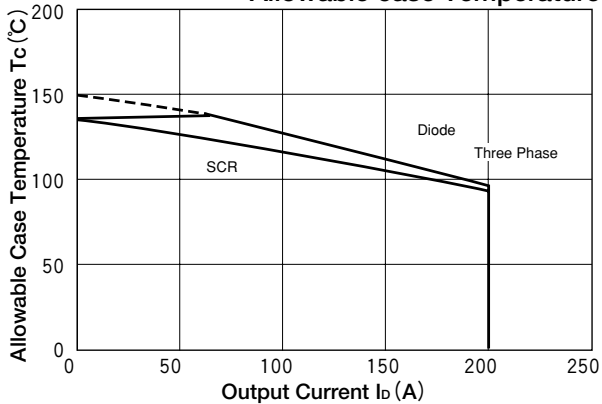

DIODE Surge Forward Current Rating (Non-Repetitive)

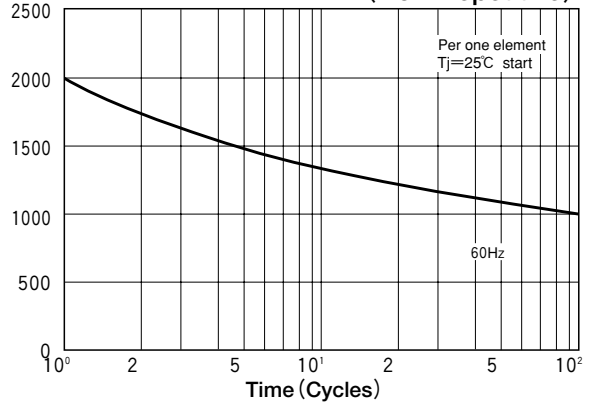

DIODE Transient Thermal Impedance

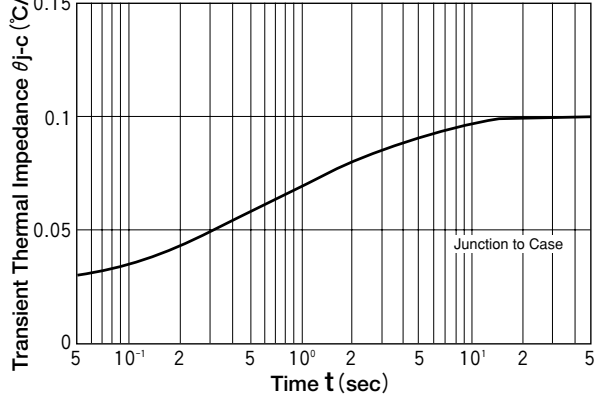

Gate Characteristics

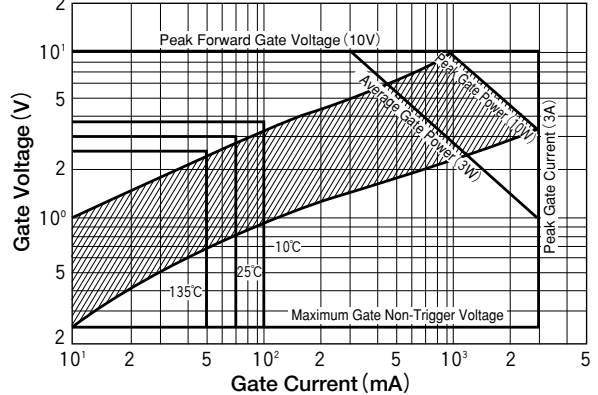

SCR On-State Characteristics

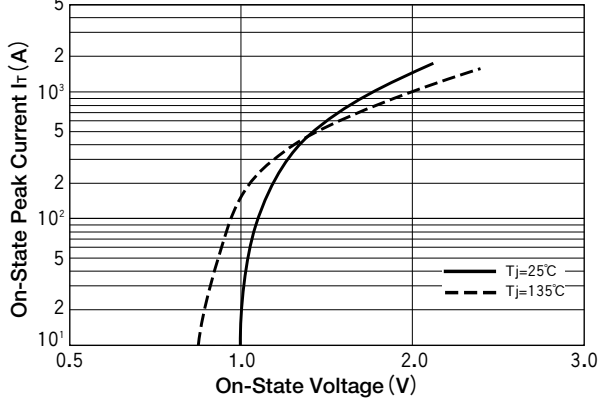

Surge On-State Current Rating (Non-Repetitive)

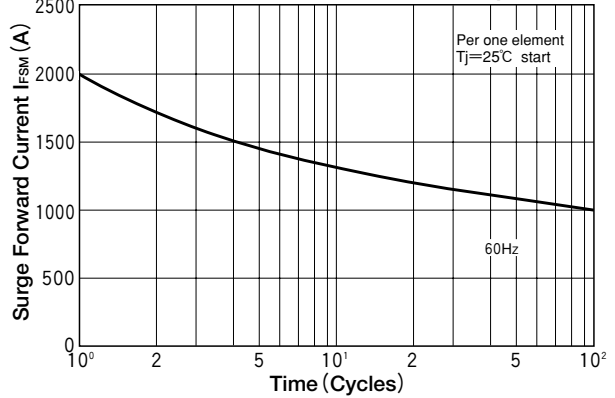

SCR Transient Thermal Impedance

